

AS AND A-LEVEL PHYSICS

AS (7407)
A-level (7408)

Required practical handbook

Version 2.1
July 2022



This is the **Physics** version of this practical handbook.

The sections on tabulating data, significant figures, uncertainties, graphing and subject specific vocabulary are particularly useful for students and could be printed as a student booklet by schools.

The information in this document is correct, to the best of our knowledge as of September 2017.

Key

There have been a number of changes to how practical work will be assessed in the new A-levels. Some of these have been AQA-specific, but many are by common agreement between the Joint Council for Qualifications (JCQ) exam boards and Ofqual.

The symbol  signifies that **all JCQ exam boards** have agreed to this.

The symbol  is used where the information relates to **AQA only**.

Contents

Introduction.....	4
Practical work in reformed A-level Biology, Chemistry and Physics.....	7
Practical skills assessment in question papers	12
Guidelines for supporting students in practical work	18
Use of lab books.....	20
Cross-board statement on CPAC.....	22
Criteria for the assessment of practical competency.....	23
Extra information on the endorsement	25
Monitoring visits.....	28
Evidence for the endorsement	32
Cross-board apparatus and techniques and AQA required activities.....	34
Tabulating data.....	37
Significant figures	38
Uncertainties	39
Graphing.....	47
Subject specific vocabulary	57
Practical ladders and example experiments.....	60
Appendix: questions from teachers	136

Introduction

Practical work brings science to life, helping students make sense of the universe around them. That's why we've put practical work at the heart of our Biology, Chemistry and Physics A-levels. Practical science allows scientific theory to transform into deep knowledge and understanding – scientific thinking. Through investigation, students uncover the important links between their personal observations and scientific ideas.

“In the best schools visited, teachers ensured that pupils understood the ‘big ideas’ of science. They made sure that pupils mastered the investigative and practical skills that underpin the development of scientific knowledge and could discover for themselves the relevance and usefulness of those ideas.”

Ofsted report

[Maintaining Curiosity. A survey into science education in schools.](#)

November 2013, No. 130135

The purpose of this practical handbook

This handbook has been developed to support you in advancing your students to fluency in science.

Over the years, there have been many rules developed for practical work in Biology, Chemistry and Physics. Some have been prescriptive, some have been intended as guidance. Although we have always attempted to be consistent within subjects, differences have emerged over time. For example, students taking Physics may also be taking Biology and find themselves confronted with contradictory rules and guidance.

This practical handbook is an attempt to harmonise the rules and guidance for Biology, Chemistry and Physics. There are occasions where these will necessarily be different, but we will try to explain why on the occasions where that happens.

The A-level specifications accredited for first teaching in September 2015 bring with them a complete change in the way practical work is assessed.

We have worked with teachers, technicians and examiners to produce this handbook. Unless specified, all guidance is common to Biology, Chemistry and Physics at both AS and A-level and subject-specific examples are for illustration only. However, the extent to which a particular aspect is assessed will differ. Teachers should refer to the specifications and specimen materials on aqa.org.uk/science for more information.

The purpose of practical work

There are three interconnected, but separate, reasons for doing practical work in schools and colleges. They are:

1. To support and consolidate **scientific concepts** (knowledge and understanding).

This is done by applying and developing what is known and understood of abstract ideas and models. Through practical work we are able to make sense of new information and observations, and provide insights into the development of scientific thinking.

2. To develop **investigative skills**. These transferable skills include:

- devising and investigating testable questions
- identifying and controlling variables
- analysing, interpreting and evaluating data.

3. To build and master **practical skills** such as:

- using specialist equipment to take measurements
- handling and manipulating equipment with confidence and fluency
- recognising hazards and planning how to minimise risk.

By focusing on the reasons for carrying out a particular practical, teachers will help their students understand the subject better, to develop the skills of a scientist and to master the manipulative skills required for further study or jobs in STEM subjects.

The reformed A-levels in Biology, Chemistry and Physics separate the ways in which practical work is assessed. This is discussed in the next section.

Fluency in science practical work

At the beginning of a Year 12 course, students will need support and guidance to build their confidence. This could involve, for example, breaking down practicals into discrete sections or being more explicit in instructions. Alternatively, a demonstration of a key technique followed by students copying may support their development. This could be a better starting point than 'setting students loose' to do it for themselves.

Progression in the mastery of practical skills and techniques shows increasing independence and confidence.

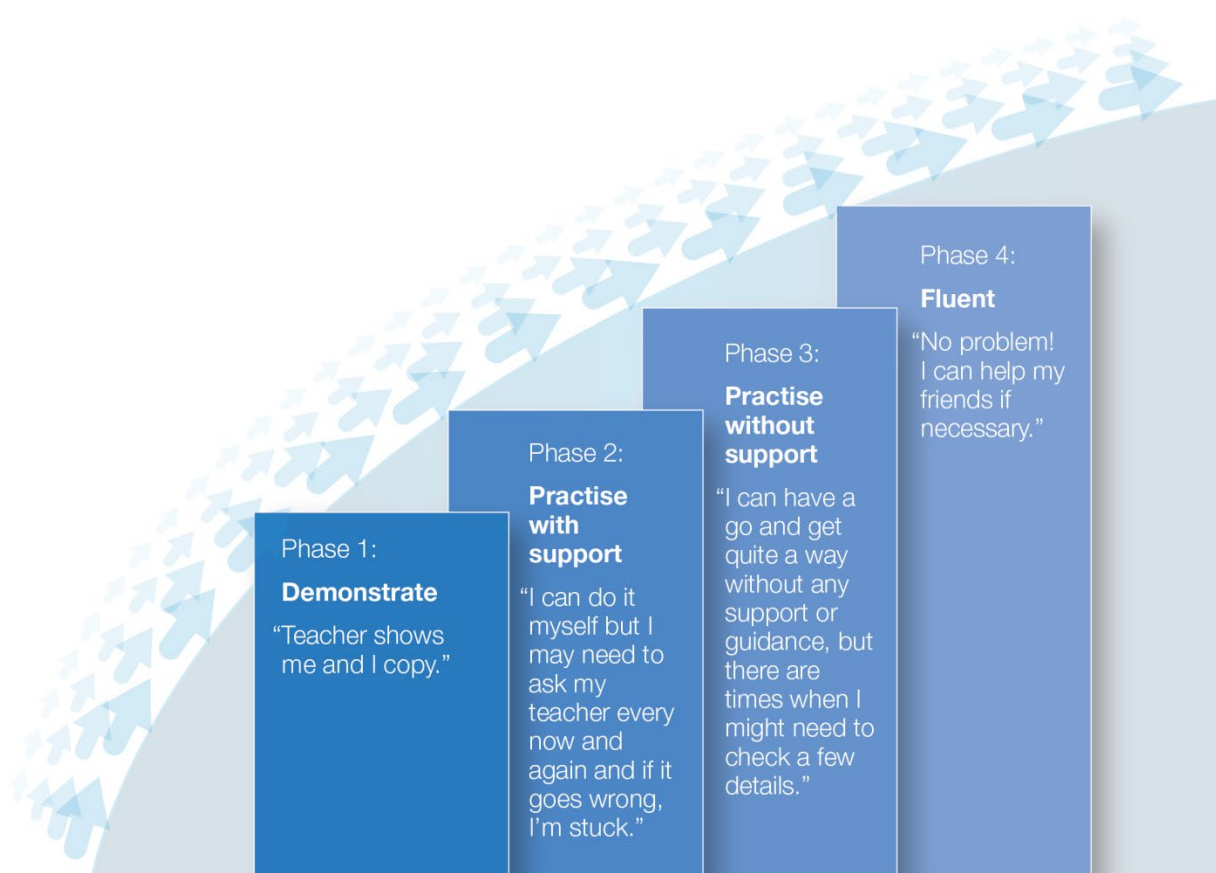

Safety is always the responsibility of the teacher. No student should be expected to assess risks and then carry out their science practical without the support and guidance of their teacher.

Practical work in reformed A-level Biology, Chemistry and Physics

Statement on practical work by Glenys Stacey, Chief Regulator at Ofqual, April 2014

“Practical work and experimentation is at the heart of science. It matters to science students, their teachers and their future universities and employers. But A-level students do not always have the chance to do enough of it.

Practical work counts for up to 30 per cent of the final grades and the vast majority of students get excellent marks for it, but still many enter university without good practical skills.

It is possible to do well in science A-levels without doing sufficient or stretching hands-on science, and other pressures on schools can make it difficult for science teachers to carve out enough time and resource to do it if students can get good A-level grades in any event. That is not right – so why is it so?

Students are assessed and marked on their performance in set tasks, but these are generally experiments that are relatively easy to administer and not particularly stretching. It has proved extremely difficult to get sufficient variety and challenge in these experiments, and so students do well even if they have not had the opportunity to do enough varied and stretching experimentation, and learn and demonstrate a variety of lab skills. What to do?

In future, science A-level exams will test students’ understanding of experimentation more so than now. Those who have not had the chance to design, conduct and evaluate the results from a good range of experiments will struggle to get top grades in those exams. They will also be required to carry out a minimum of 12 practical activities across the two year course – practical activities specific to their particular science, and that are particularly valued in higher education. Students will receive a separate grade for their practical skills (a pass/fail grade).

These reforms should place experimentation and practical skills at the heart of science teaching, where they should be. Students going to university to study a science are more likely to go well prepared. The reforms will also change the game for science teachers, enabling them to teach science in a more integrated and stimulating way and with more hands on science. Teachers will be able to say with justification that, without sufficient time and effort put into lab work, their students will struggle to get the grades they deserve.”

Glenys Stacey, Chief Regulator

[The Ofqual blog: Practical Science.](#)

This contains public sector information licensed under the Open Government License v.3.0.

The reformed AS and A-level specifications will have **no** direct assessment of practical work that contributes to the AS or A-level grades.

There are **two** elements to the practical work that students must carry out in their study of A-level Biology, Chemistry and Physics:

Apparatus and techniques

These have been agreed by all Awarding Organisations (EBs), so all students will have experienced similar practical work after following a science A-level course.

All

Examples:

- use of a light microscope at high power and low power, including use of a graticule
- purify a solid product by recrystallization
- use a laser or light source to investigate characteristics of light.

12 required practical activities

These have been specified by AQA. They cover the apparatus and techniques for each subject – so teachers do not have to worry about whether they are all covered.

AQA

Examples:

- use of aseptic techniques to investigate the effect of antimicrobial substances on microbial growth
- carry out simple test-tube reactions to identify cations and anions in aqueous solution
- determination of g by a free-fall method.

These will be assessed in two ways:

1. Questions in the written papers, assessed by AQA

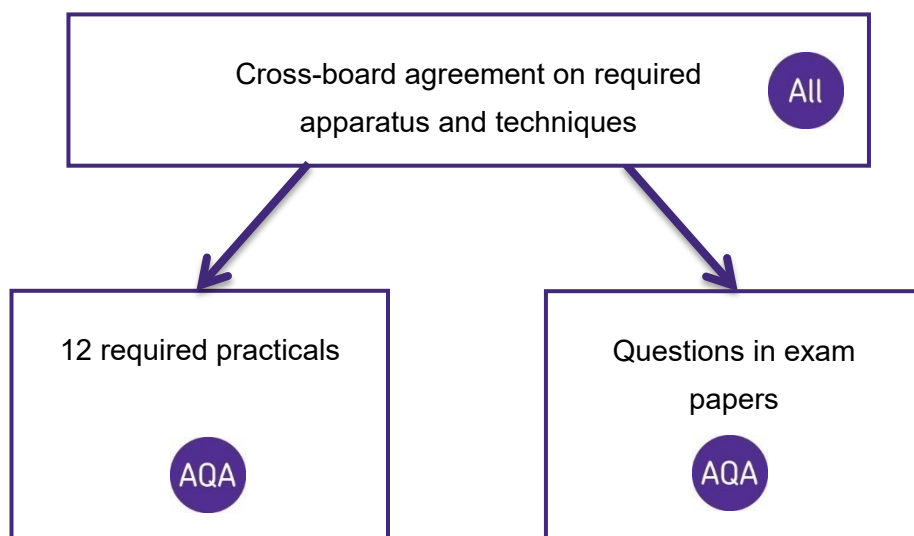

2. The practical endorsement, directly assessed by teachers.

Teachers will assess student competence at carrying out practical work. They will assess each student on at least 12 different occasions. This could be whilst teaching the 12 required practicals, or could be during other practical work of sufficient challenge.

At the end of the course, teachers will decide whether or not to award a pass in the endorsement of practical skills. The teacher must be confident that the student has shown a level of mastery of practical work **good enough for the student to go on to study science subjects at university.**

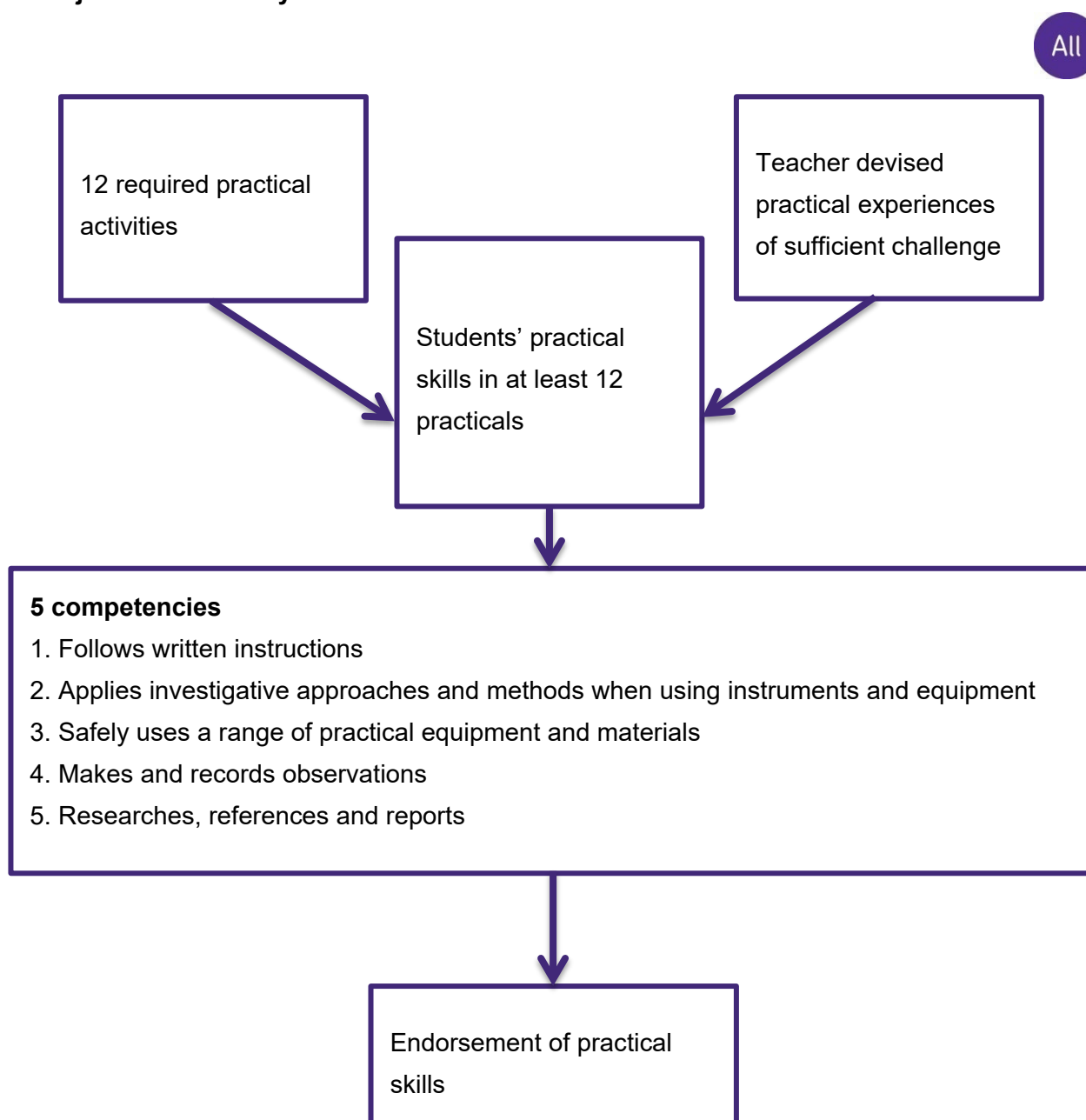

Students who miss a required practical activity

Written exam papers

The required practical activities are part of the specification. As such, exam papers could contain questions about the activities and assume that students understand those activities. A student who misses a particular practical activity may be at a disadvantage when answering questions in the exams.

It will often be difficult to set up a practical a second time for students to catch up, although if at all possible an attempt should be made. Teachers will need to decide on a case by case basis whether they feel it is important for the student to carry out that particular practical. This is no different from when teachers make decisions about whether to re-teach a particular topic if a student is away from class when it is first taught.

Endorsement

To fulfil the requirements of the endorsement, every student must carry out a minimum of 12 practicals. A student who misses one of the required practicals must carry out another practical to be able to gain the endorsement.

In most cases, this can be any experiment of A-level standard. However, students must have experienced use of each of the apparatus and techniques. In some cases, a particular apparatus and technique is only covered in one required practical activity. If a student misses that activity, the teacher will need to provide an opportunity for the student to carry out a practical that includes that activity. The list below shows the apparatus and techniques that are covered by one activity only, as well as alternatives to the required practical.

There is a possibility that the student could be asked questions about the required activity in written papers that would not be fully understood by carrying out the alternative. This should be considered when deciding whether to repeat the required activity.

If a student misses this required practical activity...	...they won't have covered this apparatus and technique.	Other practicals within an A-level Physics course involving this skill
2. Investigation of interference effects to include the Young's slit experiment and interference by a diffraction grating.	j. use laser or light source to investigate characteristics of light, including interference and diffraction.	Use diffraction (interference) grating mounted at end of rulers arranged in T-shape to view and take measurements of pattern produced when viewing monochromatic light source or TAP Teaching Advanced Physics - Episode 322: Diffraction gratings
3. Determination of g by free-fall method.	d. use stopwatch or light gates for timing.	Using dynamics trolley, ramp and light gates to verify the suvat equations.
12. Investigation of the inverse-square law for gamma radiation.	l. use ionising radiation, including detectors.	Absorption of alpha, beta and/or gamma radiation by different thicknesses of material. (Note: activity 12 was chosen to illustrate an example of an inverse square law relationship. Students would need to have experience of this as well, perhaps in a computer simulation or in an experiment involving an LDR and lamp).

Practical skills assessment in question papers

The AS and A-level papers will contain the following types of questions which relate to practical work:

1. Questions set in a practical context, where the question centres on the science, not the practical work.

Example (A-level Biology Specimen Paper 1)

Scientists measured translocation in the phloem of trees. They used carbon dioxide labelled with radioactive ^{14}C .

They put a large, clear plastic bag over the leaves and branches of each tree and added $^{14}\text{CO}_2$. The main trunk of the tree was not in the plastic bag.

At regular intervals after adding the $^{14}\text{CO}_2$ to the bag, the scientists measured the amount of $^{14}\text{CO}_2$ released from the top and bottom of the main trunk of the tree. On the surface of the trunk of these trees, there are pores for gas exchange.

Figure 7 shows the scientists' results.

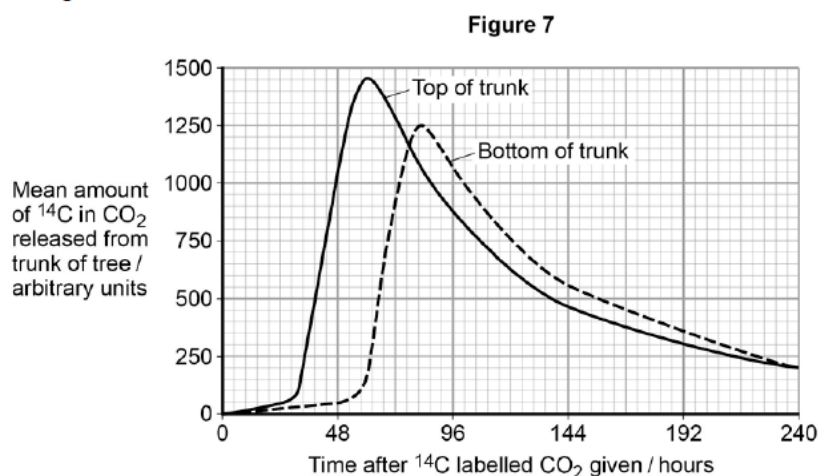

- 0 9 . 2 Name the process that produced the $^{14}\text{CO}_2$ released from the trunk. [1 mark]

- 0 9 . 3 How long did it take the ^{14}C label to get from the top of the trunk to the bottom of the trunk? Explain how you reached your answer. [2 marks]

- 0 9 . 4 What other information is required in order to calculate the mean rate of movement of the ^{14}C down the trunk? [1 mark]

These questions are set in the context of practical work that has been carried out.

However, the questions relate more to the basic Biology behind the situation, or mathematical skills.

Example (AS Chemistry Specimen Paper 1)

4 Colourless solutions of $X(aq)$ and $Y(aq)$ react to form an orange solution of $Z(aq)$ according to the following equation.

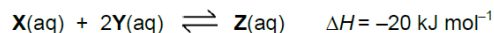

A student added a solution containing 0.50 mol of $X(aq)$ to a solution containing 0.50 mol of $Y(aq)$ and shook the mixture. After 30 seconds, there was no further change in colour. The amount of $Z(aq)$ at equilibrium was 0.20 mol.

0 4 . 1 Deduce the amounts of $X(aq)$ and $Y(aq)$ at equilibrium.

[2 marks]

Amount of $X(aq)$ = _____ mol Amount of $Y(aq)$ = _____ mol

This question requires an understanding of the underlying chemistry, not the practical procedure undertaken.

Example (A-level Physics Specimen Paper 3)

0 2 . 6 The experiment is performed with a capacitor of nominal value $680 \mu\text{F}$ and a manufacturing tolerance of $\pm 5\%$. In this experiment the charging current is maintained at $65 \mu\text{A}$. The data from the experiment produces a straight-line graph for the variation of pd with time. This shows that the pd across the capacitor increases at a rate of 98 mV s^{-1} .

Calculate the capacitance of the capacitor.

[2 marks]

capacitance = _____ μF

This question is set in a practical context, and particular readings need to be used to calculate the answer, but the specific practical set-up is not important.

2. Questions that require specific aspects of a practical procedure to be understood in order to answer a question about the underlying science.

Example (A-level Biology Specimen Paper 2)

8 Chloroplasts contain chlorophyll a and chlorophyll b. Scientists found tobacco plants with a mutation that caused them to make more chlorophyll b than normal tobacco plants. They investigated the effect of this mutation on the rate of photosynthesis.

The scientists carried out the following investigation.

- They grew normal and mutant tobacco plants. They grew some of each in low light intensity and grew others in high light intensity.
- They isolated samples of chloroplasts from mature plants of both types.
- Finally, they measured oxygen production by the chloroplasts they had isolated from the plants.

Figure 7 shows the scientists' results.

Figure 7

0 8 . 1 Explain why the scientists measured the rate of production of oxygen in this investigation. [2 marks]

This question requires the students to understand how oxygen production can be used as a proxy measure for photosynthesis, but no other details of the practical procedure are important.

Example (AS Chemistry Specimen Paper 2)

0 1 . 4 The effect of gentle heat on maleic acid is shown below.

A student predicted that the yield of this reaction would be greater than 80%.

In an experiment, 10.0 g of maleic acid were heated and 6.53 g of organic product were obtained.

Is the student correct? Justify your answer with a calculation using these data. [2 marks]

To answer this question, the student must understand the process of yield calculation (which will have been gained through practical work), but again the details of the practical procedure are unimportant.

3. Questions directly on the required practical procedures.

Example (AS Biology Specimen Paper 1)

2 A technician investigated the effect of temperature on the rate of an enzyme-controlled reaction. At each temperature, he started the reaction using the same volume of substrate solution and the same volume of enzyme solution.

Figure 2 shows his results.

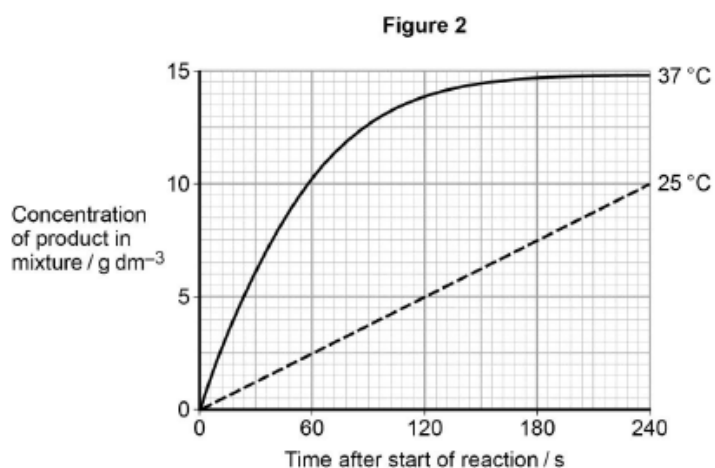

0 2 . 1 Give one other factor the technician would have controlled. [1 mark]

0 2 . 2 Calculate the rate of reaction at 25 °C. [2 marks]

Similarly, in this example, the students should have done a very similar experiment.

The first question is simple recall of the factors involved in the rate of enzyme controlled reactions.

The second requires the calculation of a gradient, which is a skill students will have learned through their practical and other work.

Example (A-level Chemistry Specimen Paper 3)

3 A peptide is hydrolysed to form a solution containing a mixture of amino acids. This mixture is then analysed by silica gel thin-layer chromatography (TLC) using a toxic solvent. The individual amino acids are identified from their R_f values.

Part of the practical procedure is given below.

1. **Wearing plastic gloves to hold a TLC plate**, draw a pencil line 1.5 cm from the bottom of the plate.
2. Use a capillary tube to apply a very small drop of the solution of amino acids to the mid-point of the pencil line.
3. Allow the spot to dry completely.
4. In the developing tank, add the developing solvent to **a depth of not more than 1 cm**.
5. Place your TLC plate in the developing tank.
6. Allow the developing solvent to rise up the plate **to the top**.
7. Remove the plate and quickly mark the position of the solvent front with a pencil.
8. Allow the plate to dry **in a fume cupboard**.

0 3 . 1 Parts of the procedure are in bold text.

For each of these parts, consider whether it is essential and justify your answer. [4 marks]

Students who have completed the related required practical will have a greater understanding of each of the steps in the procedure and will be able to explain each in turn.

4. Questions applying the skills from the required practical procedures and the apparatus and techniques list.

Example (A-level Chemistry Specimen Paper 3)

0 1 . 3 The boiling points of the organic compounds in a reaction mixture are shown in Table 1.

Table 1

Compound	ethanol	ethanal	ethanoic acid
Boiling point / °C	78	21	118

Use these data to describe how you would obtain a sample of ethanal from a mixture of these three compounds. Include in your answer a description of the apparatus you would use and how you would minimise the loss of ethanal. Your description of the apparatus can be either a description in words or a labelled sketch. [5 marks]

This question expects students to understand distillation which is one of the required practicals. It is not necessary for students to have carried out this precise experiment to understand the requirements.

Example (AS Physics Specimen Paper 2)

0 2

Data analysis question

Capillary action can cause a liquid to rise up a hollow tube. Figure 3 shows water that has risen to a height h in a narrow glass tube because of capillary action.

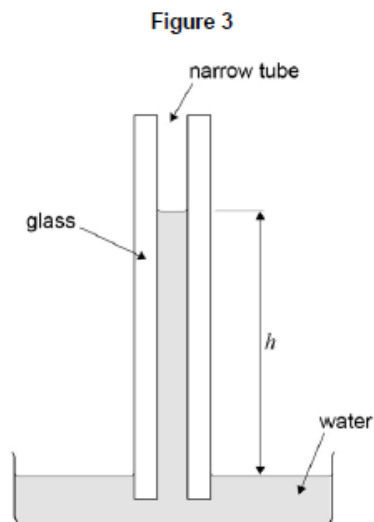
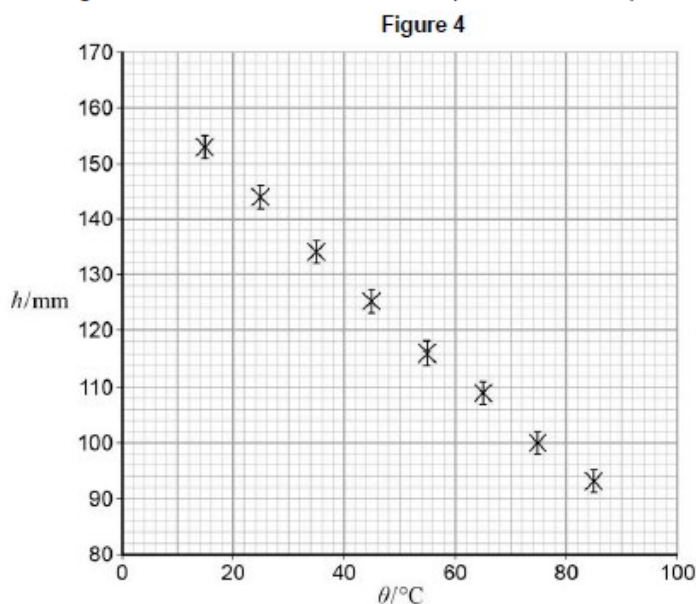

Figure 4 shows the variation of h with temperature θ for this particular tube.



The uncertainty in the measurement of h is shown by the error bars. Uncertainties in the measurements of temperature are negligible.

0 2 . 1 Draw a best-fit straight line for these data (Figure 4).

[1 mark]

0 2 . 2 It is suggested that the relationship between h and θ is

$$h = h_0 - (h_0 k) \theta$$

where h_0 and k are constants.

Determine h_0 .

[1 mark]

This question requires students to apply the data analysis skills gained through their practical work and apply it to an unusual situation.

Guidelines for supporting students in practical work

Developed in collaboration with NFER and CLEAPSS

Clarify the importance of keeping a lab book or other records of practical work

Explain that students need a record of their achievements to guide their learning. Lab books also can be an opportunity to develop a skill used both by scientists and in business. They allow students to accurately and clearly record information, ideas and thoughts for future reference which is a very useful life skill.

Warn students against plagiarism and copying

Explain the meaning of the term plagiarism and that the use of acknowledged sources is an encouraged and acceptable practice, but trying to pass off other people's work as their own is not, and will not help them learn. Show students how sources should be cited.

Explain the learning criteria for each skill

This will help students learn and allow them to know when they have met the criteria. The student lab book contains the criteria, but they own the process and have the responsibility for collecting appropriate evidence of success.

Use clearly defined learning outcomes

For example, if you are running a practical session to teach students how to use a microscope and staining techniques safely and efficiently, then make sure they know why they are learning this. This will also make it much easier for them to know when they have met the criteria.

Start with simple tasks initially

Students need to become confident with the apparatus and concepts of practical work before they can proceed to more complicated experiments. It may be more effective to start with simple manipulation skills and progress to the higher order skills.

Teach practical work in your preferred order

Teach the skills as you see fit and suit your circumstances – the assessment process is aimed to be flexible and help you teach practical work, not to dictate how it should be done.

Use feedback and peer assessment

Feedback is essential to help students develop skills effectively. Allowing self and peer review will allow time for quality feedback as well as provide powerful learning tools. However, this is a decision for teachers. The scheme is designed to be flexible while promoting best practice.

Research shows that feedback is the best tool for learning in practical skills. Students who normally only receive numerical marks as feedback for work will need to be trained in both giving and receiving comment-based feedback. Provided it is objective, focused on the task and meets learning outcomes, students will quickly value this feedback.

Feedback does not need to be lengthy, but it does need to be done while the task is fresh in the students' mind. Not everything needs written feedback but could be discussed with students, either individually or as a class. For example, if a teacher finds that many students cannot calculate percentage change, the start of the next lesson could be used for a group discussion about this.

The direct assessment of practical work is designed to allow teachers to integrate student-centred learning (including peer review), into day-to-day teaching and learning. This encourages critical

skills. Research indicates these are powerful tools for learning. For example, teachers could ask students to evaluate each other's data objectively. The students could identify why some data may be useful and some not. This can be a very good way of getting students to understand why some conventions are used, and what improves the quality of results. This also frees up marking time to concentrate on teaching.

Don't give marks

We have deliberately moved away from banded criteria and marks to concentrate on the mastery of key practical competencies. The purpose of marking should be changed to emphasise learning. Students should find it easier to understand and track their progress, and focus their work. We would expect most students, with practice and the explicit teaching of skills and techniques, to succeed in most competencies by the end of the course.

Use group work

This is a very useful skill, allowing students to build on each other's ideas. For example, planning an experiment can be done as a class discussion. Alternatively, techniques such as snowballing can be used, in which students produce their own plan then sit down in a small group to discuss which are the best collective ideas. From this, they revise their plan which is then discussed to produce a new 'best' plan.

Use of lab books

Students do **not** need to write up every practical they do in detail. However, it is good practice to have a record of all they do. A lab book could contain this. It is a student's personal book and may contain a range of notes, tables, jottings, reminders of what went wrong, errors identified and other findings. It is a live document that can function as a learning journal.

Lab books are **not** a requirement of the CPAC endorsement or the AQA AS and A-level specifications in Biology, Chemistry or Physics. They are highly valued by colleagues in higher education and are an easy way for students to demonstrate their mastery of Competence 5 "Researches, references and reports".

Each institution has its own rules on lab book usage. The following guidelines are based on those from a selection of companies and universities that use lab books. They are designed to help students and teachers in preparing to use lab books for university but do not represent the only way that books could be used for A-level sciences. Teachers may wish to vary the following points to suit their purposes.

The purpose of a lab book

A lab book is a complete record of everything that has been done in the laboratory. As such, it becomes important both to track progress of experiments, and also, in industry and universities, to prove who developed an idea or discovered something first.

A lab book is a:

- source of data that can be used later by the experimenter or others
- complete record of what has been done so that experiments could be understood or repeated by a competent scientist at some point in the future
- tool that supports sound thinking and helps experimenters to question their results to ensure that their interpretation is the same one that others would come to
- record of why experiments were done.

Type of book

Spiral bound notebooks are not recommended as it is too easy to rip a page out and start again. It is generally advisable that a lab book has a cover that won't disintegrate the moment it gets slightly wet. A lab book is often a hard-backed book with bound pages.

Style

Notes should be recorded as experiments are taking place. They should not be a "neat" record written at a later date. However, they should be written clearly, in legible writing and in language which can be understood by others.

Many lab books are used in industry as a source of data, and so should be written in indelible ink.

To ensure that an observer can be confident that all data are included when a lab book is examined, there should be no blank spaces. Mistakes should be crossed out and re-written. Numbers should not be overwritten, erased, or covered over. Pencil should not be used for anything other than graphs and diagrams.

Each page should be dated

Worksheets, graphs, printed information, photographs and even flat “data” such as chromatograms or TLC plates can all be stuck into a lab book. They should not cover up any information as this is not compatible with photocopying. Anything glued in should lie flat and not be folded.

Content

Generally, lab books will contain:

- title and date of experiment
- notes on the objectives of the experiment (eg apparatus and techniques covered or CPAC assessed)
- notes on the method, including all details (eg temperatures, volumes, settings of pieces of equipment) with justification where necessary
- estimates of the uncertainty of measurements
- sketches of how equipment has been set up can be helpful. Photographs pasted in are also acceptable
- data and observations input to tables (or similar) while carrying out the experiment
- calculations – annotated to show thinking
- graphs and charts
- summary, discussions and conclusions
- cross-references to earlier data and references to external information.

This list and its order are not prescriptive. Many experiments change as they are set up and trials run. Often a method will be given, then some data, then a brief mention of changes that were necessary, then more data and so on.

Cross-board statement on CPAC

Common Practical Assessment Criteria (CPAC)

The assessment of practical skills is a compulsory requirement of the course of study for A-level qualifications in biology, chemistry and physics. It will appear on all students' certificates as a separately reported result, alongside the overall grade for the qualification. The arrangements for the assessment of practical skills are common to all EBs.

- A minimum of 12 practical activities to be carried out by each student which, together, meet the requirements of Appendices 5b (Practical skills identified for direct assessment and developed through teaching and learning) and 5c (Use of apparatus and techniques) from the prescribed subject content, published by the Department for Education. The required practical activities will be defined by each EB in their specification.
- Teachers will assess students using Common Practical Assessment Criteria (CPAC) issued jointly by the EBs. The CPAC are based on the requirements of Appendices 5b and 5c of the subject content requirements published by the Department for Education, and define the minimum standard required for the achievement of a pass.
- Each student will keep an appropriate record of their practical work, including their assessed practical activities.
- Students who demonstrate the required standard across all the requirements of the CPAC will receive a 'pass' grade.
- There will be no separate assessment of practical skills for AS qualifications.
- Students will answer questions in the AS and A level examination papers that assess the requirements of Appendix 5a (Practical skills identified for indirect assessment and developed through teaching and learning) from the prescribed subject content, published by the Department for Education. These questions may draw on, or range beyond, the practical activities included in the specification.

Criteria for the assessment of practical competency

Competency	Practical mastery
	<p>In order to be awarded a pass, a student must, by the end of the practical science assessment, consistently and routinely meet the criteria in respect of each competency listed below. A student may demonstrate the competencies in any practical activity undertaken as part of that assessment throughout the course of study.</p> <p>Students may undertake practical activities in groups. However, the evidence generated by each student must demonstrate that he or she independently meets the criteria outlined below in respect of each competency. Such evidence:</p> <ul style="list-style-type: none"> a. will comprise both the student's performance during each practical activity and his or her contemporaneous record of the work that he or she has undertaken during that activity, and b. must include evidence of independent application of investigative approaches and methods to practical work.
1. Follows written procedures	a. Correctly follows written instructions to carry out experimental techniques or procedures.
2. Applies investigative approaches and methods when using instruments and equipment	<ul style="list-style-type: none"> a. Correctly uses appropriate instrumentation, apparatus and materials (including ICT) to carry out investigative activities, experimental techniques and procedures with minimal assistance or prompting. b. Carries out techniques or procedures methodically, in sequence and in combination, identifying practical issues and making adjustments when necessary. c. Identifies and controls significant quantitative variables where applicable, and plans approaches to take account of variables that cannot readily be controlled. d. Selects appropriate equipment and measurement strategies in order to ensure suitably accurate results.
3. Safely uses a range of practical equipment and materials	<ul style="list-style-type: none"> a. Identifies hazards and assesses risks associated with these hazards, making safety adjustments as necessary, when carrying out experimental techniques and procedures in the lab or field. b. Uses appropriate safety equipment and approaches to minimise risks with minimal prompting.

4. Makes and records observations	a. Makes accurate observations relevant to the experimental or investigative procedure. b. Obtains accurate, precise and sufficient data for experimental and investigative procedures and records this methodically using appropriate units and conventions.
5. Researches, references and reports	a. Uses appropriate software and/or tools to process data, carry out research and report findings. b. Cites sources of information demonstrating that research has taken place, supporting planning and conclusions.

Extra information on the endorsement

The information below is based on the cross-board agreements, but is not in every case cross-board agreed wording.

'Consistently and routinely'

Teachers should be confident that their students can demonstrate a particular competence going forwards. This means that demonstrating a competence once to the expected standard is unlikely to be enough, but there is no stipulated number of times that each competence must be demonstrated. The teacher should use professional judgement when holistically assessing their students at the end of the course.

Observing differences in standard over time

There is an expectation that students will improve in their skills and abilities in practical work throughout a two-year course. An adviser attending a school in the earlier part of the course would expect to see students working at a lower level than the same students would be working at by the end of the course.

There are many different ways of tracking students' skills development towards competence. Advisers will not expect to see any particular method of tracking or showing this development during visits. Advisers will discuss tracking with teachers in order to become confident that the teachers understand the standard expected at the end of the course and that their planning supports students' skills progression.

Demonstrations

Demonstrations cannot be substituted for any of the required practical activities. Teachers can demonstrate experiments when teaching new techniques, before students carry out the experiment in subsequent lessons. However, if CPAC 1 is being assessed, the instructions must not simply repeat what was shown in the demonstration.

The link between the apparatus and techniques and CPAC

All students should have experienced use of each of the apparatus and techniques. Their competence in practical work will be developed through the use of these apparatus and techniques. However, students are not being assessed on their abilities to use a particular piece of equipment, but on their general level of practical competence.

Simulations

Simulations are not acceptable for use in the place of the apparatus and techniques.

Helping students during practical work

Teachers can help students during practical work, but the amount of guidance will be dependent on the criteria being assessed. For example, if a student was being assessed on CPAC 3, and needed to be reminded on the basics of safety, they could not be assessed as passing.

It may be appropriate to help students through spot demonstrations if the equipment or the technique is new or unusual.

The amount of help would depend on when in the course the practical work was taking place. For example, at the beginning of Year 12 the teacher would be likely to be giving a lot of guidance, and tasks would include a lot of support. By the end of Year 13, there is likely to be minor prompting to help students as they become more confident and competent.

Language used by students

In written exams, students are expected to use scientific language that corresponds to the glossary of terms in this handbook. Whilst doing practical work, students should be encouraged to use the correct terms (such as discussing if results are 'accurate', 'precise', 'repeatable' etc), but should not be penalised for using incorrect vocabulary verbally. This is because the assessment is about the students' abilities in practical work, not their use of terms.

Standardisation within centres

It is expected that there is communication and training within centres such that the outcomes for learners are consistent, independent of teaching staff. Whilst the opportunity for standardisation is not the same as with internally marked controlled assessments, there should be dialogue and the possibility for observations of other staff to ensure the comparability of outcomes. The common requirements of the Practical Endorsement allow centres to assure that the criteria for the Common Practical Assessment Criteria (CPAC) are being implemented and recorded in all situations, including those where A-levels from different EBs are being delivered by one centre.

Candidate and centre records

There is no requirement for centres to retain candidate records. Candidate records are only required for review at the time of the monitoring visit. Similarly, there is no requirement for centres to retain centre records after completion of the course.

Certificates

Students will either have 'Pass' or 'Not classified' recorded on their certificate for the endorsement.

Resit candidates

Resit candidates who have passed the requirements for the practical endorsement may carry this result forward. They are not required to repeat the practical activities to achieve a pass grade, but may choose to repeat them along with the teaching and learning to increase their knowledge and understanding for the written exams.

JCQ are organising a national record of candidates who have achieved a pass in the practical endorsement, which may be accessed by an EB to assure that a candidate is eligible for the carry forward of their practical endorsement pass. This will include candidates who achieve an unclassified U grade in the exam and who will not have the outcome of the practical endorsement certificated.

Teachers who accept resit candidates from a different school, college or tuition centre should insist on having sight of the candidate certificate as proof of practical endorsement pass.

If the candidate is also resitting the practical endorsement, as they have failed to meet the pass standard in all CPAC criteria previously, teachers will need to assess all CPAC, not just areas of weakness highlighted previously.

Reasonable adjustments

The [JCQ document *Access Arrangements and Reasonable Adjustments*](#) sets out arrangements for access arrangements for all assessments.

The arrangements applicable to the endorsement must not compromise the objectives of the assessment. So, for example, it may be reasonable for a student to have a reader or extra time while being assessed against CPAC 1. Students would be demonstrating their ability to follow instructions in the form the students were used to receiving them.

CPAC 2 and 3 make reference to the use of instruments, equipment and materials. The use of a practical assistant for a student with very poor motor coordination or a severe visual impairment could potentially compromise the purpose of the assessment (to develop manipulative skills).

Teachers should work with the special educational needs coordinator to determine which arrangements are appropriate and reasonable.

Tutorial colleges, private entries and home schooling

The provision of the Practical Endorsement and associated practical activities is a regulatory requirement. Any centre not providing opportunities to demonstrate the competences for a minimum of twelve practical activities, is in breach of the regulations for the reformed GCE Advanced level science qualifications. The same applies to centres that have not had a monitoring visit to confirm that they are assessing their students correctly against the CPAC. These breaches are subject to a series of sanctions from the regulator such as those for malpractice or maladministration, which will be instigated by the EB conducting monitoring of the centre, and communicated with all other EBs.

Candidates resitting the assessment at tutorial colleges may have demonstrated competence in all the practical requirements at a previous centre. Providing that centre passed its monitoring visit, the evidence of prior completion allows entry for the resit with a carry-forward of the practical endorsement result.

Private candidates can be entered for exams at a centre even if they are not enrolled there. Private candidates may be home-schooled, receiving private tuition or may be self-taught. The Practical Endorsement is an essential part of the course and will allow candidates to develop skills for further study or employment as well as imparting important knowledge that is part of the specification. Private candidates should have the opportunity to complete the Practical Endorsement and should, therefore, ensure that they are registered with a centre that has passed a monitoring visit and has this provision available. The centre may charge for this facility and it is recommended that any such arrangement is made early in the course.

New centres

Any new centre starting to deliver one of the sciences at A-level should notify the exam board with whom they intend to make entries so that a monitoring visit can be scheduled during the teaching of the first cohort.

Switching exam boards

If a centre switches exam board they should notify the monitor when they make contact. The monitor will then pass this information to the new board to allow them to carry out the visit.

Contact details for the AQA monitoring team can be found in the Crossboard messaging in the [Practical endorsements](#) pages of our website.

Monitoring visits

We are committed to making the monitoring process a supportive one. Monitoring is not like an Ofsted visit, it's an opportunity for students to show off their learning, and for teachers to show their teaching. It isn't a 'big stick' - it should be positive and helpful.

We refer to our monitors as advisers

Advisers will be looking to confirm two things:

- that schools are **compliant** with the **rules**
- that teachers are **assessing** students at the correct **standard**.

All schools have now been monitored for one subject by one of the boards during the first two years of the course. For example, if a school is taking Biology with AQA, while Chemistry and Physics with other boards, AQA have only visited the Biology department, and another board may have visited Chemistry or Physics. Larger schools and colleges (who tend to have separate departments) will have been visited three times, one visit to each department. AQA's first visits took place between January and April 2016. Remaining first visits took place between September 2016 and May 2017. A similar pattern of visits is now intended throughout the lifetime of the specification.

Cross-board agreed process and code of conduct

Process		
1	EB	Collates all visits and outcomes from previous exam series and agrees on allocation and subject for monitoring.
2	EB	Arranges monitoring visits and allocates advisers.
3	Adviser	Visits centre. Feeds back to EB and school.

Training

Training on the standard is free and [available on our website](#). **The Lead Teacher for each science must undertake this compulsory training** and disseminate information to their subject team as requested by their EB.

Lead Teachers are not required to be the same person as previously notified to JCQ or the EBs, and there is no need to notify JCQ or the EB of any such staffing change.

Lead Teachers continuing in post do not have to repeat the training, but will want to ensure that any staff who are new to their centre are fully aware of the requirements of the Practical Endorsement.

Notice of monitoring

Each EB is expected to give schools or colleges at least two weeks' notice of monitoring visits. Where possible, EBs may take into account the school/college's timetables, but on most occasions it will be necessary for the school/college to make arrangements to allow the adviser to observe a practical lesson.

Materials required by the adviser on the day of the visit:

- documented plans to carry out sufficient practical activities which meet the requirements of CPAC, incorporating skills and techniques detailed in appendix 5, over the course of the A-level.
- a record of each practical activity undertaken and the date when this was completed
- a record of the criteria being assessed in that practical activity
- a record of student attendance
- a record of which student met the criteria and which did not
- student work showing evidence required for the particular task with date
- any associated materials provided for the practical activity, eg written instructions given

A timetable for the day and lists of people who the adviser will meet will also be required.

Notes on evidence

- Evidence 1: although there is an expectation that planning to cover the full requirements of the endorsement should take place, plans may be in outline form if seen in the first year of the course.
- Evidence 2–6: will only be available after particular activities have taken place. The adviser should take a proportionate view on whether sufficient practical activities have taken place by the time of the visit.
- Evidence 7: a similarly proportionate view should be taken on this requirement.

Before the day of monitoring

The adviser will communicate expectations with the centre, explaining the process, evidence required, the staff and students who will be observed or spoken to, and make arrangements for the day.

On the day of monitoring

The timings of the monitoring visit will be discussed with the centre and will be dependent on the number of students.

Advisers will be expected to:

- meet the Lead Teacher for the endorsement of practical work for the subject being visited
- observe a lesson including a practical activity (which may or may not be one of the required practicals) during which students are assessed against the competencies
- discuss the teacher's assessment of the students in the class
- meet students and discuss the practical work that students have been doing (this may take place during the lesson if appropriate)
- view the work of students from lesson and other classes as per cross-board agreement
- view teachers' records of assessment of practical work
- follow all rules and procedures as required by the school.

Advisers may undertake formal or informal monitoring for an additional A-level subject when in a school or college where teachers are using the adviser's EB and have requested or agreed to such monitoring.

Advisers will under no circumstances:

- attempt to persuade teachers who are not currently teaching for the advisers' EB to change EBs
- attempt to persuade teachers to change EBs for GCSE or other courses
- collect information about teachers' names and EBs for subjects not taking exams with the adviser's board
- meet teachers for A-level subjects where the board used is not the adviser's board except where training is on another qualification where the teacher uses the adviser's board (for example, when a teacher uses different boards for GCSE and A-level)
- accept any sort of gifts from the school or teachers
- make notes that could be constituted as a "lesson observation", or feedback any judgement on teaching and learning to the teacher or school
- make audio, video or photographic records of students without prior explicit permission being granted by the senior leadership of the school and the parents of the students involved
- remove any original students' work from the centre at the end of the visit
- expect teachers to be using a particular method of planning, teaching or assessment.

Feedback

The adviser will not give a formal judgement during the visit. Feedback will be received by the centre following review by the Lead adviser within two weeks of the visit.

A copy of the report will be sent electronically to the Head teacher, Lead Teacher and the exams officer. Please ensure your school server accepts email from AQA.

Follow up actions

On occasion, the adviser may require supplementary evidence. These will generally be any actions that can take place remotely (for example emailing or sending evidence or documents to the adviser).

Non-compliant centres

Centres that have not met the required standard will be reported to cross-board parties for follow up, which may include a follow up visit for the subject and/or monitoring for the other subjects.

Safety

At all times the adviser should comply with health and safety regulations and the instructions of the teacher unless they would put the adviser at risk. The safety of students is the responsibility of the teacher. In particular, advisers should not be left alone with classes, especially where practical work is taking place. Advisers should be chaperoned at all times.

Is the adviser role for you?

All of our advisers are practising teachers with a passion for practical work teaching. If you are interested in becoming one of our advisers, look out for our regular job advertisements.

Evidence for the endorsement

Schools/colleges will be visited by an adviser who will agree with teachers a date for their visit. They will observe practical work taking place and discuss their views of the competencies exhibited by the students with the teacher present.

All

There should be no need to coach students for this visit, as it is the teachers' abilities to assess practical work that are being monitored, not the students' performance.

The following minimum documentation requirements have been agreed by the awarding bodies, and would be expected to be available to the adviser to view. There is currently no requirement for any of the following to be sent into the EB.

There are many ways of fulfilling these requirements. We believe that teachers should have the ability to choose the methods they use to collect this documentation. Different schools and colleges will find different ways to track this information depending on local needs. We will be providing example methods of tracking this information, but will not require teachers to use specific forms. Advisers will be trained by AQA and will accept the following methods, or alternatives which contain the required information.

AQA

1. Documented plans to carry out sufficient practical activities which meet the requirements of CPAC, incorporating skills and techniques detailed in appendix 5, over the course of the A-level.

Appendix 5 here refers to the DfE subject criteria. The apparatus and techniques are listed in the specifications on the AQA website, as well as the next section in this handbook.

Teachers may wish to keep this information in the following ways:

- long-term schemes of work which include the required practicals (and any other practicals where teachers will be assessing students' competencies)
- timetables or lists of dates of each of the practicals
- sheets stuck in the front of students' lab books.

2. A record of each practical activity undertaken and the date when this was completed.

3. A record of the criteria being assessed in that practical activity.

These records could be kept:

- in long-term scheme of work, there may be bullet points after each practical identifying the competencies to be completed
- on student sheets, the competences that the teacher will be assessing could be detailed
- on tracking spreadsheets.

4. A record of student attendance.

This could be done via normal school systems if teachers feel that cross-referencing between SIMS or similar and their schemes of work allow them to be confident that all students have done each experiment.

Alternative methods could include:

- tracking spreadsheets
- teacher mark books
- sheets stuck at the front of students' lab books.

5. A record of which student met the criteria and which did not.

Examples of how this could be recorded:

- tracking spreadsheets
- on individual pieces of work/lab book pages
- an overview page per student at the front of lab books.

6. Student work showing evidence required for the particular task with date.

Teachers must be confident that they are able to assess the quality of students' work in accordance with the relevant CPAC criteria. For example:

- in lab books (allowing all practical work to be kept in one place)
- in students' folders, interspersed with their theory work (allowing the link between practical and theory to be highlighted)
- in computer-based systems
- on individual sheets collected at the end of practical sessions
- in pre-printed workbooks.

In each case, teachers must be able to locate students' work if an adviser visits the centre and asks to see it.

7. Any associated materials provided for the practical activity, eg written instructions given.

This could include:

- notes in lesson plans or schemes of work
- worksheets or workbooks
- notes made on tracking sheets.

These materials should allow an adviser to understand how much guidance students were given. For example, they could show that teachers gave students full details of an experiment, which would limit the ability of the students to demonstrate the ability to apply investigative approaches.

Cross-board apparatus and techniques and AQA required activities

The apparatus and techniques lists for Biology, Chemistry and Physics are common to all boards. Students taking any specification in these subjects are expected to have had opportunities to use the apparatus and develop and demonstrate the techniques throughout the duration of the course.

The required practical activities in each subject are specific to AQA. We have written our specifications so that AS is co-teachable with the A-level specification. Therefore the first six required practicals are included in both specifications and the second six are A-level only.

Carrying out the 12 required practicals in the full A-level will mean that students will have experienced each of the expected apparatus and techniques. Teachers are encouraged to develop students' abilities by inclusion of other opportunities for skills development, as exemplified in the right-hand column of the content section of the specification.

Teachers are encouraged to vary their approach to the required practical activities. Some are more suitable for highly structured approaches that develop key techniques. Others allow opportunities for students to develop investigative approaches.

This list is not designed to limit the practical activities carried out by students. A rich practical experience for students will include more than the 12 required practical activities. The explicit teaching of practical skills builds students' competence. Many teachers will also use practical approaches to the introduction of content knowledge in the course of their normal teaching. Students' work in these activities can also contribute towards the endorsement of practical skills.

For the endorsement, all students must have experienced use of one of the alternatives in the apparatus and techniques list. For example, in Physics students can pass the endorsement if they have used digital or vernier scales.

However, to best prepare students for exams, teachers should ensure that all students understand each of the alternatives so they can answer questions on practical work that involve any of these.

Therefore, all "or" statements in the apparatus and techniques list should be viewed as "and" statements for the written exams.

We are keen to encourage teachers to use alternative methods that support students to develop their understanding of the apparatus and techniques statements. More detailed advice, additional activities and alternative methods can be found on the [CLEAPSS website](#).

Whichever method you use, it is your responsibility to check that you have covered all aspects of the apparatus and techniques criteria.

Physics apparatus and techniques

All

Apparatus and techniques

ATa	Use appropriate analogue apparatus to record a range of measurements (to include length/distance, temperature, pressure, force, angles, volume) and to interpolate between scale markings
ATb	Use appropriate digital instruments, including electrical multimeters, to obtain a range of measurements (to include time, current, voltage, resistance, mass)
ATc	Use methods to increase accuracy of measurements, such as timing over multiple oscillations, or use of fiduciary marker, set square or plumb line
ATd	Use stopwatch or light gates for timing
ATe	Use calipers and micrometers for small distances, using digital or vernier scales
ATf	Correctly construct circuits from circuit diagrams using DC power supplies, cells, and a range of circuit components, including those where polarity is important
ATg	Design, construct and check circuits using DC power supplies, cells, and a range of circuit components
ATh	Use signal generator and oscilloscope, including volts/division and time-base
ATi	Generate and measure waves, using microphone and loudspeaker, or ripple tank, or vibration transducer, or microwave/radio wave source
ATj	Use laser or light source to investigate characteristics of light, including interference and diffraction
ATk	Use ICT such as computer modelling, or data logger with a variety of sensors to collect data, or use of software to process data
ATI	Use ionising radiation, including detectors

Physics required activities (1-6 AS), (1-12 A-level)

Required activity	Apparatus and technique reference
1. Investigation into the variation of the frequency of stationary waves on a string with length, tension and mass per unit length of the string	a, b, c, i
2. Investigation of interference effects to include the Young's slit experiment and interference by a diffraction grating	a, j
3. Determination of g by a free-fall method	a, c, d, k
4. Determination of the Young modulus by a simple method	a, c, e
5. Determination of resistivity of a wire using a micrometer, ammeter and voltmeter	a, b, e, f
6. Investigation of the emf and internal resistance of electric cells and batteries by measuring the variation of the terminal pd of the cell with current in it	b, f, g
7. Investigation into simple harmonic motion using a mass-spring system and a simple pendulum	a, b, c, h, i
8. Investigation of Boyle's (constant temperature) law and Charles' (constant pressure) law for a gas	a
9. Investigation of the charge and discharge of capacitors. Analysis techniques should include log-linear plotting leading to a determination of the time constant RC	b, f, g, h, k
10. Investigate how the force on a wire varies with flux density, current and length of wire using a top pan balance	a, b, f
11. Investigate, using a search coil and oscilloscope, the effect on magnetic flux linkage of varying the angle between a search coil and magnetic field direction	a, b, f, h
12. Investigation of the inverse-square law for gamma radiation	a, b, k, l

Tabulating data

It is important to keep a record of data while carrying out practical work. Tables should have clear headings with units indicated using a forward slash before the unit.

pd/V	Current/A
2.0	0.15
4.0	0.31
6.0	0.45

Although using a forward slash (solidus) is the standard format, other formats are generally acceptable. For example:

Length in m	Time for 10 oscillations in s
0.600	15.52
0.700	16.85
0.800	17.91

Distance (cm)	Count rate (s^{-1})
10.0	53
15.0	25
20.0	12

It is good practice to draw a table before an experiment commences and then enter data straight into the table. This can sometimes lead to data points being in the wrong order. For example, when investigating the electrical characteristics of a component by plotting an $I - V$ curve, a student may initially decide to take current readings at pd values of 0.5, 1.0, 1.5, 2.0, 2.5, 3.0 V. On discovering a more significant change in current between 1.5 and 2.0 V, the student might decide to take further readings at 1.6, 1.7, 1.8, 1.9 V to investigate this part of the characteristics in more detail. Whilst this is perfectly acceptable, it is generally a good idea to make a fair copy of the table in ascending order of pd to enable patterns to be spotted more easily. Reordered tables should follow the original data if using a lab book.

It is also expected that the independent variable is the left hand column in a table, with the following columns showing the dependent variables. These should be headed in similar ways to measured variables. The body of the table should not contain units.

Tabulating logarithmic values

When the logarithm is taken of a physical quantity, the resulting value has no unit. However, it is important to be clear about which unit the quantity had to start with. The logarithm of a distance in km will be very different from the logarithm of the same distance in mm.

These should be included in tables in the following way:

Reading number	Time/s	Log (time/s)
1	2.3	0.36
2	3.5	0.54
3	5.6	0.75

Significant figures

Data should be written in tables to the same number of significant figures. This number should be determined by the resolution of the device being used to measure the data or the uncertainty in measurement. For example, a length of string measured to be 60 cm using a ruler with mm graduations should be recorded as 600 mm, 60.0 cm or 0.600 m, and **not** just 60 cm. Similarly a resistor value quoted by the manufacturer as 56 k Ω , 5% tolerance should **not** be recorded as 56.0 k Ω .

There is sometimes confusion over the number of significant figures when readings cross multiples of 10. Changing the number of decimal places across a power of ten retains the number of significant figures **but changes the accuracy**. The same number of decimal places should therefore generally be used, as illustrated below.

0.97	99.7
0.98	99.8
0.99	99.9
1.00	100.0
1.10	101.0

It is good practice to write down all digits showing on a digital meter.

Calculated quantities should be shown to the number of significant figures of the data with the least number of significant figures.

Example:

Calculate the size of an object if the magnification of a photo is $\times 25$ and it is measured to be 24.6 mm on the photo.

$$\text{size of real object} = \frac{\text{size of image}}{\text{magnification}}$$

$$\text{size of real object} = \frac{24.6 \times 10^{-3}}{25}$$

$$\text{size of real object} = 9.8 \times 10^{-4}$$

Note that the size of the real object can only be quoted to two significant figures as the magnification is only quoted to two significant figures.

Equipment measuring to half a unit (eg a thermometer measuring to 0.5°C) should have measurements recorded to one decimal place (eg 1.0°C, 2.5°C). The uncertainty in these measurements would be ± 0.25 , but this would be rounded to the same number of decimal places (giving measurements quoted with uncertainty of $(1.0 \pm 0.3)^\circ\text{C}$ etc).

Uncertainties

Sources of uncertainties

Students should know that every measurement has some inherent uncertainty.

The important question to ask is whether an experimenter can be confident that the true value lies in the range that is predicted by the uncertainty that is quoted. Good experimental design will attempt to reduce the uncertainty in the outcome of an experiment. The experimenter will design experiments and procedures that produce the least uncertainty and to provide a realistic uncertainty for the outcome.

In assessing uncertainty, there are a number of issues that have to be considered. These include:

- the resolution of the instrument used
- the manufacturer's tolerance on instruments
- the judgments that are made by the experimenter
- the procedures adopted (eg repeated readings)
- the size of increments available (eg the size of drops from a pipette).

Numerical questions will look at a number of these factors. Often, the resolution will be the guiding factor in assessing a numerical uncertainty. There may be further questions that require candidates to evaluate arrangements and procedures. Students could be asked how particular procedures would affect uncertainties and how they could be reduced by different apparatus design or procedure.

A combination of the above factors means that there can be no hard and fast rules about the actual uncertainty in a measurement. What we can assess from an instrument's resolution is the **minimum** possible uncertainty. Only the experimenter can assess the other factors, based on the arrangement and use of the apparatus. A rigorous experimenter would draw attention to these factors and take them into account.

Readings and measurements

It is useful, when discussing uncertainties, to separate measurements into two forms:

- readings: the values found from a single judgement when using a piece of equipment
- measurements: the values taken as the difference between the judgements of two values.

Examples

When using a thermometer, a student only needs to make one judgement (the height of the liquid). This is a reading. It can be assumed that the zero value has been correctly set.

For protractors and rulers, both the starting point and the end point of the measurement must be judged, leading to two uncertainties.

The following list is not exhaustive, and the way that the instrument is used will determine whether the student is taking a reading or a measurement.

Reading (one judgement only)	Measurement (two judgements required)
thermometer	ruler
top pan balance	vernier calliper
measuring cylinder	micrometer
digital voltmeter	protractor
Geiger counter	stopwatch
pressure gauge	analogue meter

The uncertainty in a **reading** when using a particular instrument is **no smaller** than plus or minus half of the smallest division or greater. For example, a temperature measured with a thermometer is likely to have an uncertainty of $\pm 0.5^{\circ}\text{C}$ if the graduations are 1°C apart.

Students should be aware that readings are often written with the uncertainty. An example of this would be to write a voltage as $(2.40 \pm 0.01) \text{ V}$. It is usual for the uncertainty quoted to be the same number of decimal places as the value. Unless there are good reasons otherwise (eg an advanced statistical analysis), students at this level should quote the uncertainty in a measurement to the same number of decimal places as the value.

Measurement example: length

When measuring length, **two** uncertainties must be included: the uncertainty of the placement of the zero of the ruler and the uncertainty of the point the measurement is taken from.

As both ends of the ruler have a ± 0.5 scale division uncertainty, the measurement will have an uncertainty of ± 1 division.

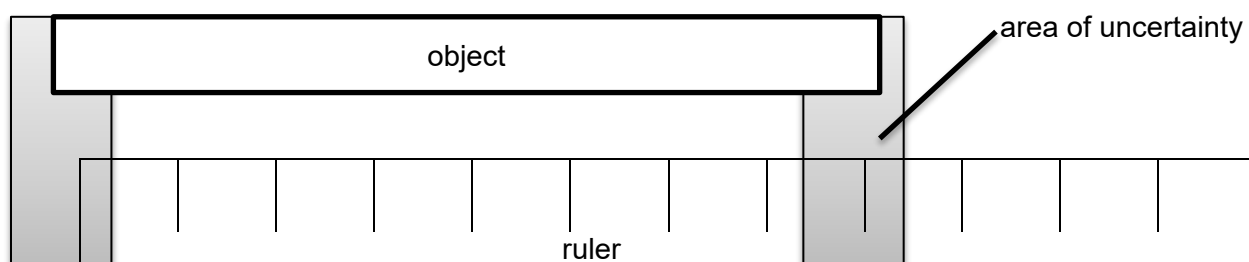

For most rulers, this will mean that the uncertainty in a measurement of length will be $\pm 1 \text{ mm}$.

This 'initial value uncertainty' will apply to any instrument where the user can set the zero (incorrectly), but would not apply to equipment such as balances or thermometers where the zero is set at the point of manufacture.

In summary

- The uncertainty of a reading (one judgement) is at least ± 0.5 of the smallest scale reading.
- The uncertainty of a measurement (two judgements) is at least ± 1 of the smallest scale reading.

The way measurements are taken can also affect the uncertainty.

Measurement example: the extension of a spring

Measuring the extension of a spring using a metre ruler can be achieved in two ways

1. Measuring the total length unloaded and then loaded.

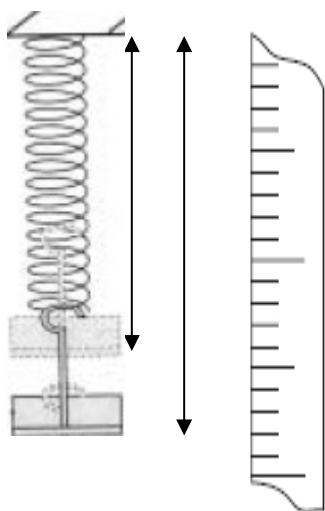

Four readings must be taken for this: the start and end point of the unloaded spring's length and the start and end point of the loaded spring's length.

The minimum uncertainty in each measured length is ± 1 mm using a meter ruler with 1 mm divisions (the actual uncertainty is likely to be larger due to parallax in this instance). The extension would be the difference between the two readings, so the minimum uncertainty would be ± 2 mm.

2. Fixing one end and taking a scale reading of the lower end.

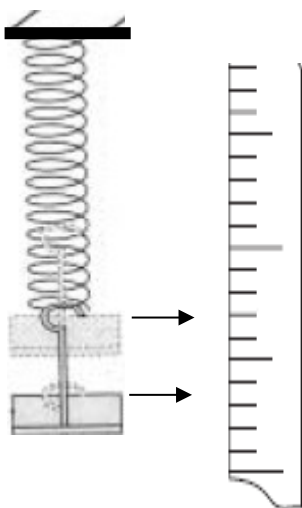

Two readings must be taken for this: the end point of the unloaded spring's length and the end point of the loaded spring's length. The start point is assumed to have zero uncertainty, as it is fixed.

The minimum uncertainty in each reading would be ± 0.5 mm, so the minimum extension uncertainty would be ± 1 mm.

Even with other practical uncertainties this second approach would be better.

Realistically, the uncertainty would be larger than this and an uncertainty in each reading of 1 mm or would be more sensible. This depends on factors such as how close the ruler can be mounted to the point as at which the reading is to be taken.

Other factors

There are some occasions where the resolution of the instrument is not the limiting factor in the uncertainty in a measurement.

Best practice is to write down the full reading and then to write to fewer significant figures when the uncertainty has been estimated.

Examples:

A stopwatch has a resolution of hundredths of a second, but the uncertainty in the measurement is more likely to be due to the reaction time of the experimenter. Here, the student should write the full reading on the stopwatch (eg 12.20 s), carry the significant figures through for all repeats, and reduce this to a more appropriate number of significant figures after an averaging process later.

If a student measures the length of a piece of wire, it is very difficult to hold the wire completely straight against the ruler. The uncertainty in the measurement is likely to be higher than the ± 1 mm uncertainty of the ruler. Depending on the number of “kinks” in the wire, the uncertainty could be reasonably judged to be nearer ± 2 or 3 mm.

The uncertainty of the reading from digital voltmeters and ammeters depends on the electronics and is not strictly the last figure in the readout. Manufacturers usually quote the percentage uncertainties for the different ranges. Unless otherwise stated it may be assumed that ± 0.5 in the least significant digit is to be the uncertainty in the measurement. This would generally be rounded up to ± 1 of the least significant digit when quoting the value and the uncertainty together. For example (5.21 ± 0.01) V. If the reading fluctuates, then it may be necessary to take a number of readings and do a mean and range calculation.

Uncertainties in given values

The value of the charge on an electron is given in the data sheet as 1.60×10^{-19} C.

In all such cases assume the uncertainty to be ± 1 in the last significant digit. In this case the uncertainty $\pm 0.01 \times 10^{-19}$ C. The uncertainty may be lower than this but without knowing the details of the experiment and procedure that lead to this value there is no evidence to assume otherwise.

Example:

If the number of lines per m is quoted as 3.5×10^3 , it is usual to assume that the uncertainty is ± 1 in the last significant figure, $\pm 0.1 \times 10^3$ since there is no indication of the uncertainties in the measurements from which that figure came.

Multiple instances of measurements

Some methods of measuring involve the use of multiple instances in order to reduce the uncertainty. For example, measuring the thickness of several sheets of paper together rather than one sheet, or timing several swings of a pendulum. The uncertainty of each measurement will be the uncertainty of the whole measurement divided by the number of sheets or swings. This method works because the absolute uncertainty on the time for a single swing is the same as the absolute uncertainty for the time taken for multiple swings, but there is a lower percentage in the time taken for multiple swings.

Example:

Time taken for a pendulum to swing 10 times: (5.1 ± 0.1) s

Mean time taken for one swing: (0.51 ± 0.01) s

Repeated measurements

Repeating a measurement is a method for reducing the uncertainty.

With many readings it's possible to also identify those that are exceptional (that are far away from a significant number of other measurements). Sometimes it will be appropriate to remove outliers from measurements before calculating a mean. On other occasions, particularly in Biology, outliers are important to include. For example, it is important to know that a particular drug produces side effects in one person in a thousand.

If measurements are repeated, the uncertainty can be calculated by finding half the range of the measured values.

For example:

Repeat	1	2	3	4
Distance/m	1.23	1.32	1.27	1.22

$1.32 - 1.22 = 0.10$ therefore

Mean distance: (1.26 ± 0.05) m

Percentage uncertainties

The percentage uncertainty in a measurement can be calculated using:

$$\text{percentage uncertainty} = \frac{\text{uncertainty}}{\text{value}} \times 100\%$$

The percentage uncertainty in a repeated measurement can also be calculated using:

$$\text{percentage uncertainty} = \frac{\text{uncertainty}}{\text{mean value}} \times 100\%$$

Further examples:

Example 1. Some values for diameter of a wire

Repeat	1	2	3	4
Diameter/mm	0.35	0.37	0.36	0.34

The exact values for the mean is 0.355 mm and for the uncertainty is 0.015 mm.

This could be quoted as such or recorded as 0.36 ± 0.02 mm given that there is a wide range and only 4 readings. Given the simplistic nature of the analysis then giving the percentage uncertainty as 5% or 6% would be acceptable.

Example 2. Different values for the diameter of a wire

Repeat	1	2	3
Diameter/mm	0.35	0.36	0.35

The mean here is 0.3533 mm with uncertainty of 0.005 mm.

The percentage uncertainty is 1.41% so may be quoted as 1% but really it would be better to obtain further data.

Uncertainties in exams

Wherever possible, questions in exams will be clear on whether students are being asked to calculate the uncertainty of a reading, a measurement, or given data.

Where there is ambiguity, mark schemes will allow alternative sensible answers and credit clear thinking.

It is important that teachers read the reports on the exam following each series to understand common mistakes to help their students improve in subsequent years.

Uncertainties in practical work

Students are expected to develop an understanding of uncertainties in measurements through their practical work. Teachers may use students' assessments of uncertainties in measurements, and their recording, as evidence towards several of the endorsement criteria. Teachers will decide on each occasion what acceptable uncertainty values are, and the ways in which they expect students to record these.

Examples:

CPAC 2: Students should be attempting to reduce the uncertainties in experiments. This could be by choosing appropriate equipment (CPAC 2d), or by choosing procedures such as repeating readings that reduce overall uncertainties (CPAC 2c).

CPAC 4: Students' records should take into account uncertainties. For example, students should be making sensible decisions about the number of significant figures to include, particularly in calculated values.

CPAC 5: Students could comment on the uncertainties in their measurements. For example, students could comment on whether the true value (eg for a concentration, or the acceleration due to gravity) lies within their calculated range of uncertainty. With some measurements, students may compare their value with those from secondary sources, contributing evidence for CPAC 5b.

Error bars in Physics

There are a number of ways to draw error bars. Students are not expected to have a formal understanding of confidence limits in Physics (unlike in Biology). The following simple method of plotting error bars would therefore be acceptable:

- plot the data point at the mean value
- calculate the range of the data, ignoring any anomalies
- add error bars with lengths equal to half the range on either side of the data point.

Uncertainties from gradients

To find the uncertainty in a gradient, two lines should be drawn on the graph. One should be the “best” line of best fit. The second line should be the steepest or shallowest gradient line of best fit possible from the data. The gradient of each line should then be found.

The uncertainty in the gradient is found by:

$$\text{percentage uncertainty} = \frac{|\text{best gradient} - \text{worst gradient}|}{\text{best gradient}} \times 100\%$$

Note the modulus bars meaning that this percentage will always be positive.

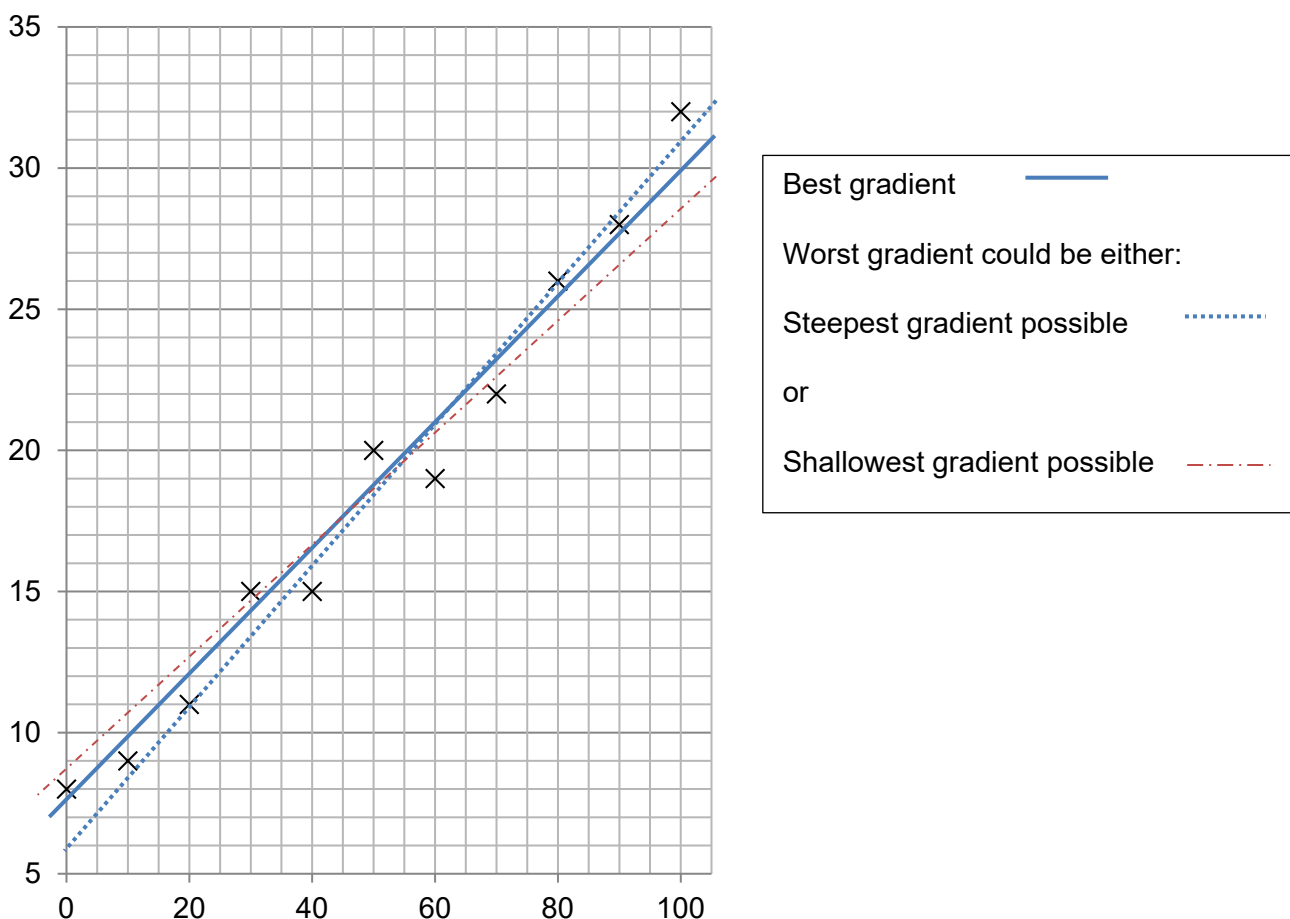

In the same way, the percentage uncertainty in the y-intercept can be found:

$$\text{percentage uncertainty} = \frac{|\text{best } y \text{ intercept} - \text{worst } y \text{ intercept}|}{\text{best } y \text{ intercept}} \times 100\%$$

Combining uncertainties

Percentage uncertainties should be combined using the following rules:

Combination	Operation	Example
Adding or subtracting values $a = b + c$	Add the absolute uncertainties $\Delta a = \Delta b + \Delta c$	Object distance, $u = (5.0 \pm 0.1)\text{cm}$ Image distance, $v = (7.2 \pm 0.1)\text{cm}$ Difference $(v - u) = (2.2 \pm 0.2)\text{cm}$
Multiplying values $a = b \times c$	Add the percentage uncertainties $\epsilon a = \epsilon b + \epsilon c$	Voltage = $(15.20 \pm 0.1)\text{ V}$ Current = $(0.51 \pm 0.01)\text{ A}$ Percentage uncertainty in voltage = 0.7% Percentage uncertainty in current = 1.96% Power = Voltage \times current = 7.75 W Percentage uncertainty in power = 2.66% Absolute uncertainty in power = $\pm 0.21\text{ W}$
Dividing values $a = \frac{b}{c}$	Add the percentage uncertainties $\epsilon a = \epsilon b + \epsilon c$	Mass of object = $(30.2 \pm 0.1)\text{ g}$ Volume of object = $(18.0 \pm 0.5)\text{cm}^3$ Percentage uncertainty in mass of object = 0.3 % Percentage uncertainty in volume = 2.8% Density = $\frac{30.2}{18.0} = 1.68\text{ g cm}^{-3}$ Percentage uncertainty in density = 3.1% Absolute uncertainty in density = $\pm 0.05\text{ g cm}^{-3}$
Power rules $a = b^c$	Multiply the percentage uncertainty by the power $\epsilon a = c \times \epsilon b$	Radius of circle = $(6.0 \pm 0.1)\text{cm}$ Percentage uncertainty in radius = 1.6% Area of circle = $\pi r^2 = 113.1\text{cm}^2$ Percentage uncertainty in area = 3.2% Absolute uncertainty = $\pm 3.6\text{cm}^2$ (Note – the uncertainty in π is taken to be zero)

Note: Absolute uncertainties (denoted by Δ) have the same units as the quantity.

Percentage uncertainties (denoted by ϵ) have no units.

Uncertainties in trigonometric and logarithmic functions will not be tested in A-level exams.

Graphing

Graphing skills can be assessed both in written papers for the A-level grade and by the teacher during the assessment of the endorsement. Students should recognise that the type of graph that they draw should be based on an understanding of the type of data they are using and the intended analysis of it. The rules below are guidelines which will vary according to the specific circumstances.

Labelling axes

Axes should always be labelled with the variable being measured and the units. These should be separated with a forward slash (solidus):

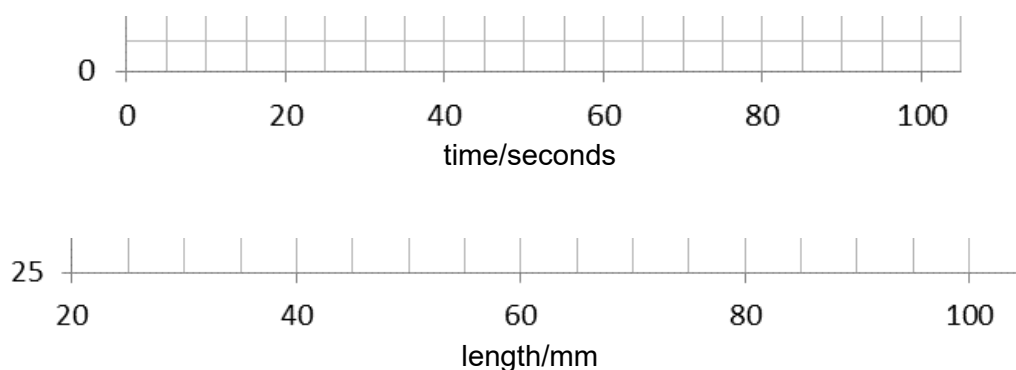

Axes should not be labelled with the units on each scale marking.

Data points

Data points should be marked with a cross. Both \times and $+$ marks are acceptable, but care should be taken that data points can be seen against the grid.

Error bars, standard deviation and ranges can take the place of data points where appropriate.

Scales and origins

Students should attempt to spread the data points on a graph as far as possible without resorting to scales that are difficult to deal with. Students should consider:

- the maximum and minimum values of each variable
- the size of the graph paper
- whether 0.0 should be included as a data point
- whether they will be attempting to calculate the equation of a line, therefore needing the y intercept (Physics only)
- how to draw the axes without using difficult scale markings (eg multiples of 3, 7, 11 etc)
- in exams, the plots should cover **at least half** of the grid supplied for the graph.

Please note that in the Uncertainties and Graphing sections, many generic graphs are used to illustrate the points made. For example, the following three graphs are intended to illustrate the information above relating to the spread of data points on a graph. Students producing such graphs on the basis of real practical work or in exam questions would be expected to add in axes labels and units.

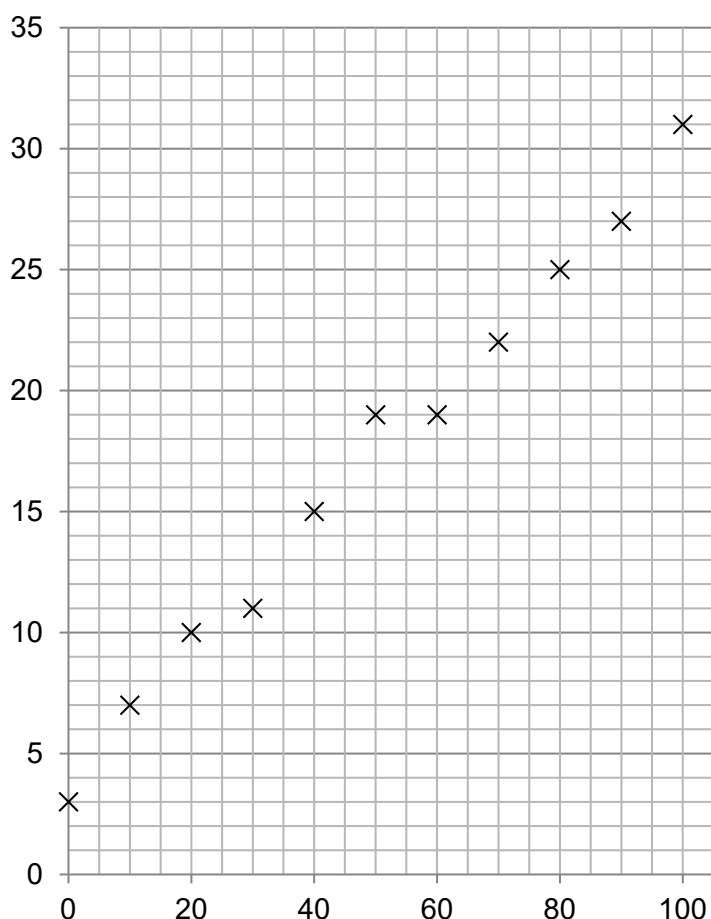

This graph has well-spaced marking points and the data fills the paper.

Each point is marked with a cross (so points can be seen even when a line of best fit is drawn).

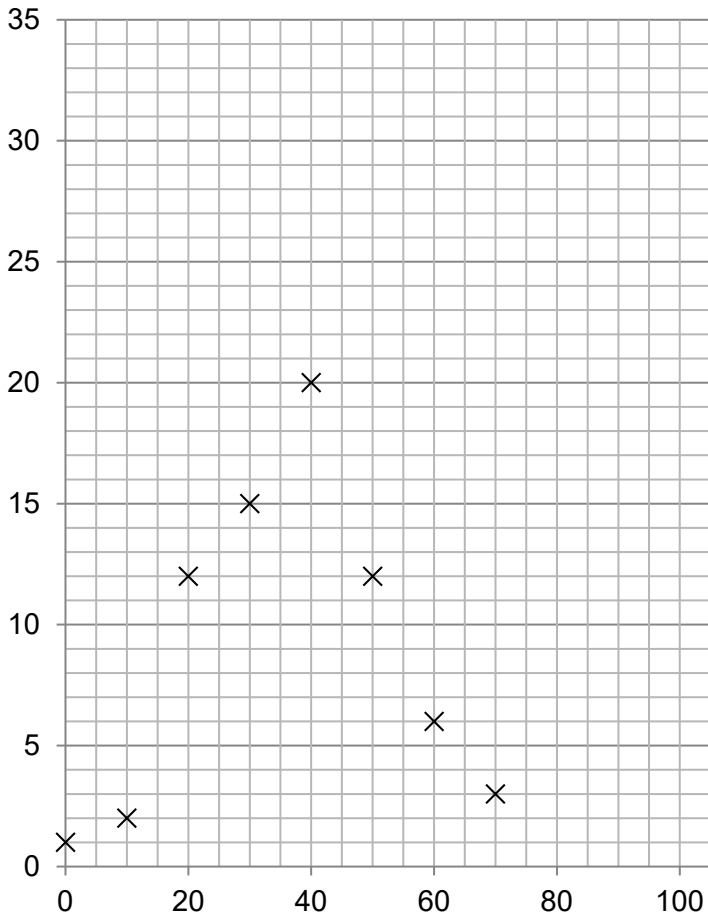

This graph is on the limit of acceptability. The points do not quite fill the page, but spreading them further would result in the use of awkward scales.

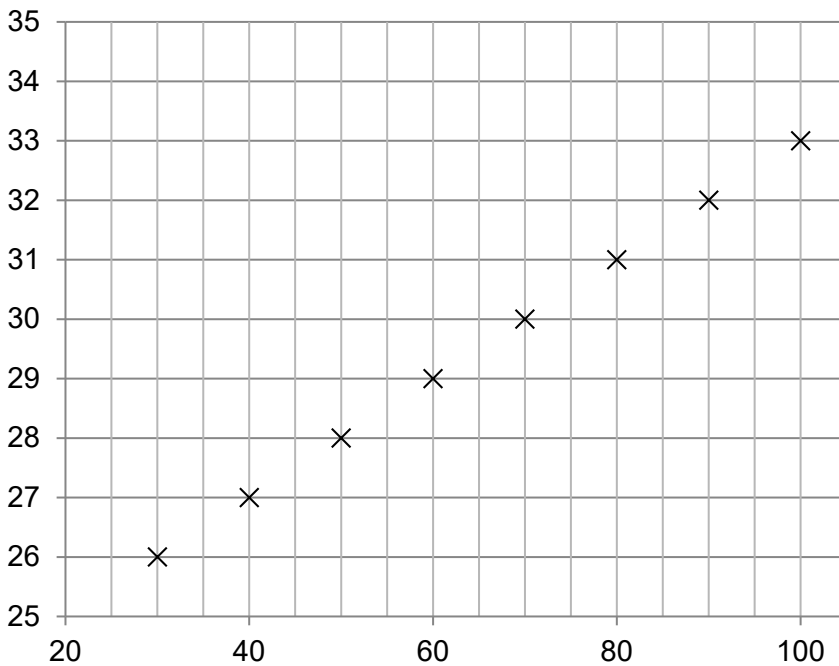

At first glance, this graph is well drawn and has spread the data out sensibly.

However, if the graph were to later be used to calculate the equation of the line, the lack of a y -intercept could cause problems. Increasing the axes to ensure all points are spread out but still including the y -intercept is a skill that requires practice and may take a couple of attempts.

Lines of best fit

Lines of best fit should be drawn when appropriate. Students should consider the following when deciding where to draw a line of best fit:

- are the data likely to be following an underlying equation (for example, a relationship governed by a physical law)? This will help decide if the line should be straight or curved
- are there any anomalous results?
- are there uncertainties in the measurements? The line of best fit should fall within error bars, if drawn.

There is no definitive way of determining where a line of best fit should be drawn. A good rule of thumb is to make sure that there are as many points on one side of the line as the other. Often the line should pass through, or very close to, the majority of plotted points. Graphing programs can sometimes help, but tend to use algorithms that make assumptions about the data that may not be appropriate.

Lines of best fit should be continuous and drawn as a thin pencil that does not obscure the points below and does not add uncertainty to the measurement of gradient of the line.

Not all lines of best fit go through the origin. Students should ask themselves whether a 0 in the independent variable is likely to produce a 0 in the dependent variable. This can provide an extra and more certain point through which a line must pass. A line of best fit that is expected to pass through (0,0), but does not, would imply some systematic error in the experiment. This would be a good source of discussion in an evaluation.

Dealing with anomalous results

At GCSE, students are often taught automatically to ignore anomalous results. At A-level, students should think carefully about what could have caused the unexpected result and therefore whether it is anomalous. A student might be able to identify a reason for the unexpected result and so validly regard it as an anomaly. For example, an anomalous result might be explained by a different experimenter making the measurement, a different solution or a different measuring device being used. In the case where the reason for an anomalous result occurring can be identified, the result should be recorded and plotted but may then be ignored.

Anomalous results should also be ignored where results are expected to be the same.

Where there is no obvious error and no expectation that results should be the same, anomalous results should be included. This will reduce the possibility that a key point is being overlooked.

Please note: when recording results it is important that all data are included. Anomalous results should only be ignored at the data analysis stage.

It is best practice whenever an anomalous result is identified for the experiment to be repeated. This highlights the need to tabulate and even graph results as an experiment is carried out.

Measuring gradients

When finding the gradient of a line of best fit, students should show their working by drawing a triangle on the line. The hypotenuse of the triangle should be at least half as big as the line of best fit.

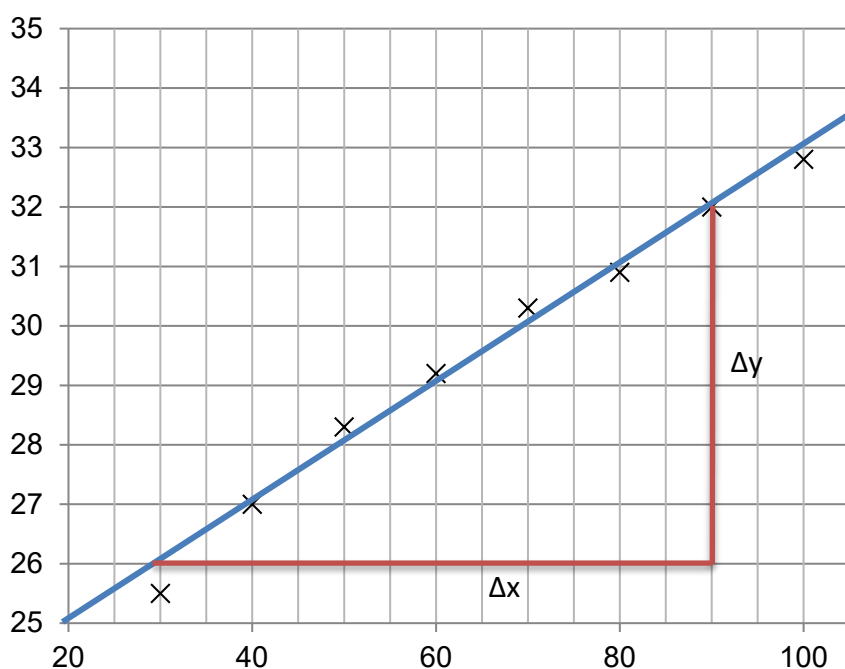

The line of best fit here has an equal number of points on both sides. It is not too wide so points can be seen under it.

The gradient triangle has been drawn so the hypotenuse includes more than half of the line.

In addition, it starts and ends on points where the line of best fit crosses grid lines so the points can be read easily (this is not always possible).

$$\text{gradient} = \frac{\Delta y}{\Delta x}$$

When finding the gradient of a curve, eg the rate of reaction at a time that was not sampled, students should draw a tangent to the curve at the relevant value of the independent variable (x-axis).

Use of a set square to draw a triangle over this point on the curve can be helpful in drawing an appropriate tangent.

The equation of a straight line

Students should be able to translate graphical data into the equation of a straight line.

$$y = mx + c$$

Where y is the dependent variable, m is the gradient, x is the independent variable and c is the y -intercept.

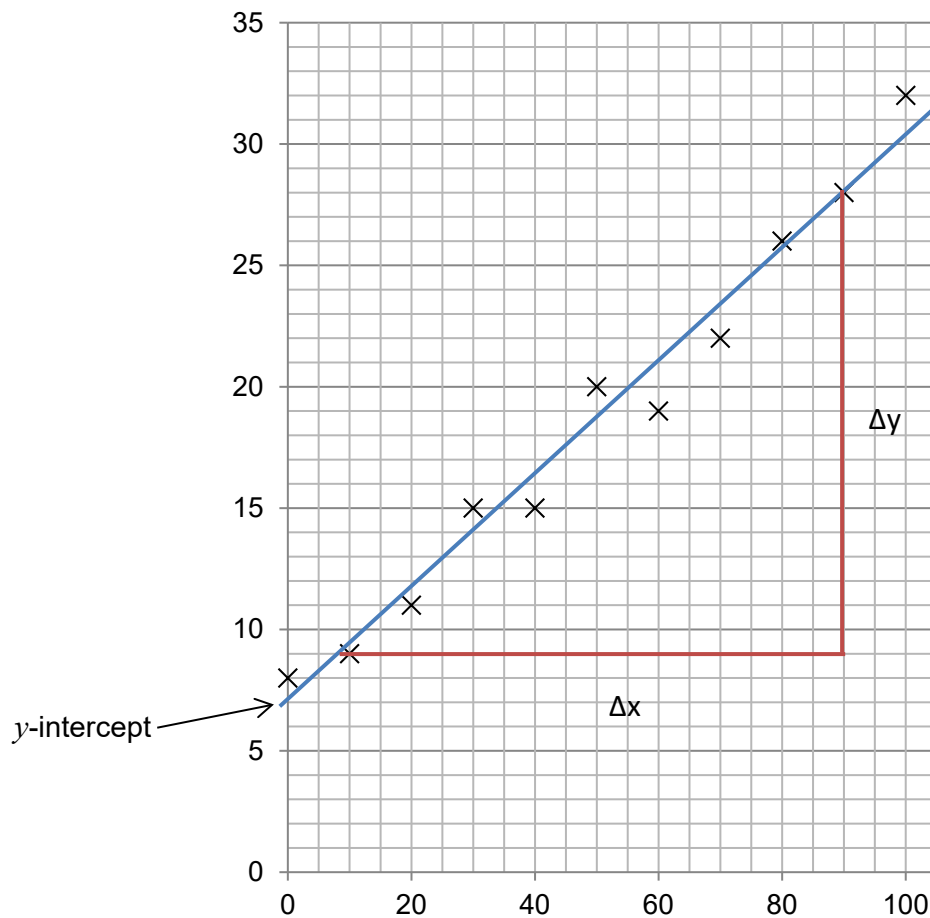

$$\Delta y = 28 - 9 = 19$$

$$\Delta x = 90 - 10 = 80$$

$$\text{gradient} = 19 / 80 = 0.24 \text{ (2 sf)}$$

$$y\text{-intercept} = 7.0$$

equation of line:

$$y = 0.24x + 7.0$$

Testing relationships

Sometimes it is not clear what the relationship between two variables is. A quick way to find a possible relationship is to manipulate the data to form a straight line graph from the data by changing the variable plotted on each axis.

For example:

Raw data and graph

x	y
0	0.00
10	3.16
20	4.47
30	5.48
40	6.32
50	7.07
60	7.75
70	8.37
80	8.94
90	9.49
100	10.00

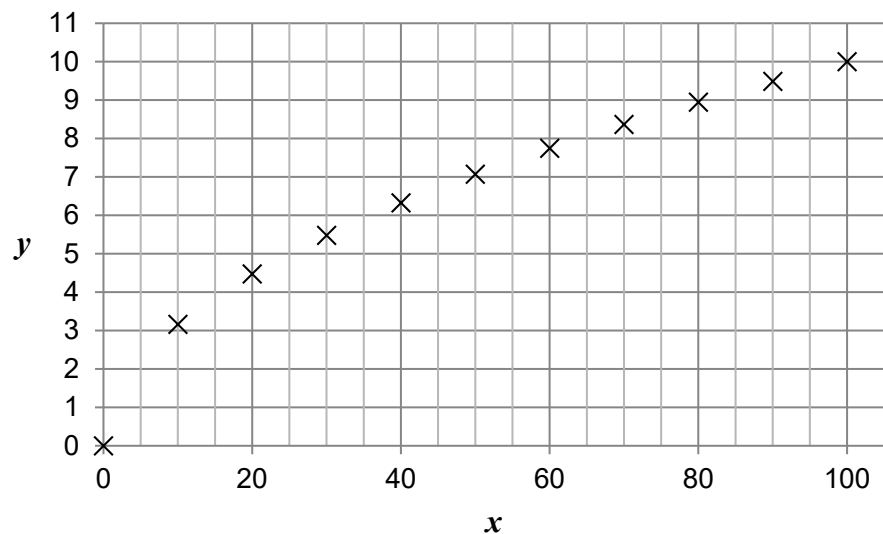

This is clearly not a straight line graph. The relationship between x and y is not clear.

Manipulated data and graphs

A series of different graphs can be drawn from these data. The one that is closest to a straight line is a good candidate for the relationship between x and y .

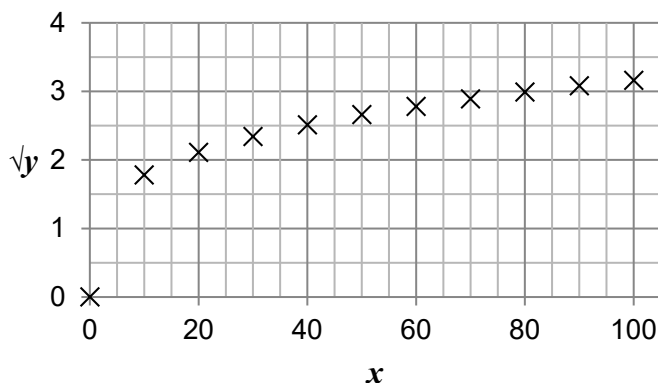

100	10.00	3.16	100.00	1000
-----	-------	------	--------	------

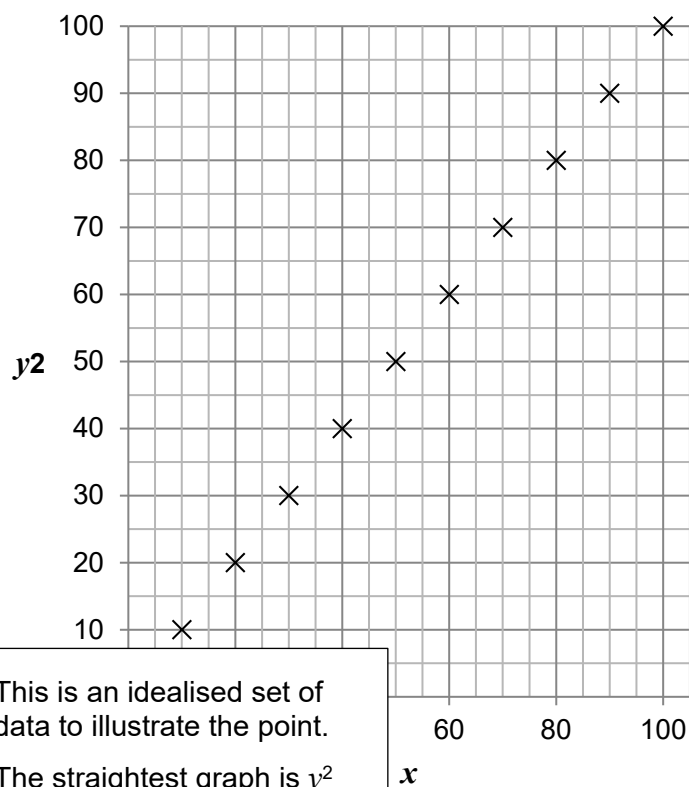

This is an idealised set of data to illustrate the point.

The straightest graph is y^2 against x , suggesting that the relationship between x and y is

$$y^2 \propto x$$

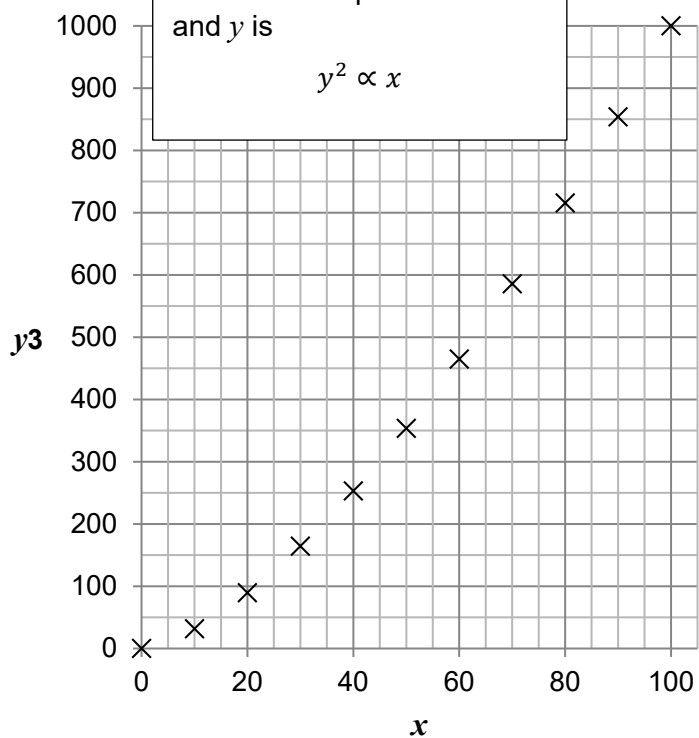

More complex relationships

Graphs can be used to analyse more complex relationships by rearranging the equation into a form similar to $y = mx + c$.

Example one

When water is displaced by an amount l in a U tube, the time period, T , varies with the following relationship:

$$T = 2\pi \sqrt{\frac{l}{2g}}$$

This could be used to find g , the acceleration due to gravity.

- Take measurements of T and l .
- Rearrange the equation to become linear:

$$T^2 = 4\pi^2 \frac{l}{2g}$$

- Calculate T^2 for each value of l .
- By re-writing the equation as:

$$T^2 = \frac{4\pi^2}{2g} l$$

It becomes clear that a graph of T^2 against l will be linear with a gradient of $\frac{4\pi^2}{2g}$.

- Calculate the gradient (m) by drawing a triangle on the graph.
- Find g by rearranging the equation $m = \frac{4\pi^2}{2g}$ into $g = \frac{4\pi^2}{2m} = \frac{2\pi^2}{m}$

Example two: testing power laws

A relationship is known to be of the form $y=Ax^n$, but n is unknown.

Measurements of y and x are taken.

A graph is plotted with $\log(y)$ plotted against $\log(x)$.

The gradient of this graph will be n , with the y intercept $\log(A)$, as $\log(y) = n(\log(x)) + \log(A)$

Example three

The equation that relates the pd, V , across a capacitor, C , as it discharges through a resistor, R , over a period of time, t .

$$V = V_0 e^{-\frac{t}{RC}}$$

Where V_0 = pd across capacitor at $t = 0$

This can be rearranged into

$$\ln V = -\frac{t}{RC} + \ln V_0$$

So a graph of $\ln V$ against t should be a straight line, with a gradient of $-\frac{1}{RC}$ and a

y -intercept of $\ln V_0$

Use of mirrors

It is possible to use mirrors in class to draw lines of best fit. However, mirrors are **not** allowed to be used in exams.

Subject specific vocabulary

The language of measurement

The following subject specific vocabulary provides definitions of key terms used in our AS and A-level science specifications. This information is accurate at the time of publication, but see our website for the most up to date [subject specific vocabulary](#).

Accuracy

A measurement result is considered accurate if it is judged to be close to the true value.

Calibration

Marking a scale on a measuring instrument.

This involves establishing the relationship between indications of a measuring instrument and standard or reference quantity values, which must be applied.

For example, placing a thermometer in melting ice to see whether it reads 0°C, in order to check if it has been calibrated correctly.

Data

Information, either qualitative or quantitative, that has been collected.

Errors

See also uncertainties.

Measurement error

The difference between a measured value and the true value.

Anomalies

These are values in a set of results which are judged not to be part of the variation caused by random uncertainty.

Random error

These cause readings to be spread about the true value, due to results varying in an unpredictable way from one measurement to the next.

Random errors are present when any measurement is made, and cannot be corrected. The effect of random errors can be reduced by making more measurements and calculating a new mean.

Systematic error

These cause readings to differ from the true value by a consistent amount each time a measurement is made.

Sources of systematic error can include the environment, methods of observation or instruments used.

Systematic errors cannot be dealt with by simple repeats. If a systematic error is suspected, the data collection should be repeated using a different technique or a different set of

equipment, and the results compared.

Zero error

Any indication that a measuring system gives a false reading when the true value of a measured quantity is zero, eg the needle on an ammeter failing to return to zero when no current flows. A zero error may result in a systematic uncertainty.

Evidence

Data which has been shown to be valid.

Fair test

A fair test is one in which only the independent variable has been allowed to affect the dependent variable.

Hypothesis

A proposal intended to explain certain facts or observations.

Interval

The quantity between readings, eg a set of 11 readings equally spaced over a distance of 1 metre would give an interval of 10 centimetres.

Precision

Precise measurements are ones in which there is very little spread about the mean value. Precision depends only on the extent of random errors – it gives no indication of how close results are to the true value.

Prediction

A prediction is a statement suggesting what will happen in the future, based on observation, experience or a hypothesis.

Range

The maximum and minimum values of the independent or dependent variables; important in ensuring that any pattern is detected.

For example a range of distances may be quoted as either:
'from 10cm to 50cm' or 'from 50 cm to 10 cm'.

Repeatable

A measurement is repeatable if the original experimenter repeats the investigation using same method and equipment and obtains the same results.

Reproducible

A measurement is reproducible if the investigation is repeated by another person, or by using different equipment or techniques, and the same results are obtained.

Resolution

This is the smallest change in the quantity being measured (input) of a measuring instrument that gives a perceptible change in the reading.

Sketch graph

A line graph, not necessarily on a grid, that shows the general shape of the relationship between two variables. It will not have any points plotted and although the axes should be labelled they may not be scaled.

True value

This is the value that would be obtained in an ideal measurement.

Uncertainty

The interval within which the true value can be expected to lie, with a given level of confidence or probability, eg “the temperature is $20^{\circ}\text{C} \pm 2^{\circ}\text{C}$, at a level of confidence of 95%.

Validity

Suitability of the investigative procedure to answer the question being asked. For example, an investigation to find out if the rate of a chemical reaction depended upon the concentration of one of the reactants would not be a valid procedure if the temperature of the reactants was not controlled.

Valid conclusion

A conclusion supported by valid data, obtained from an appropriate experimental design and based on sound reasoning.

Variables

These are physical, chemical or biological quantities or characteristics.

Categoric variables

Categoric variables have values that are labels, eg names of plants or types of material.

Continuous variables

Continuous variables can have values (called a quantity) that can be given a magnitude either by counting (as in the case of the number of shrimp) or by measurement (eg light intensity, flow rate etc).

Control variables

A control variable is one which may, in addition to the independent variable, affect the outcome of the investigation and therefore has to be kept constant or at least monitored.

Dependent variables

The dependent variable is the variable of which the value is measured for each and every change in the independent variable.

Independent variables

The independent variable is the variable for which values are changed or selected by the investigator.

Nominal variables

A nominal variable is a type of categoric variable where there is no ordering of categories (eg red flowers, pink flowers, blue flowers)

Practical ladders and example experiments

During the development of our A-levels in Biology, Chemistry and Physics, we spoke to hundreds of teachers. Teachers also helped us to decide which practical activities to include in our 12 required practicals for each subject.

Both in development and in our launch meetings, we were asked for full, comprehensive practical instructions. In response, we have included a **sample** method for each practical on the following pages. These have been prepared so that a reasonably equipped school or college can cover the required activity with their students. It gives **one possible version** of the experiment that teachers could use. They will help inform planning the time required and ensure schools and colleges have the right equipment. Many are based on existing ISA and EMPA tasks as we know they worked well and that schools and colleges are familiar with them.

Photographs of a set-up of the sample practical methods provided can be found in our mini-guide for each practical, which are available on our [practical resources page](#)

The sample methods should **only** be seen as a starting point. We do not intend to stifle innovation and would encourage teachers to try different methods. Students will not be examined on the specific practical work exemplified in this section, but on the skills and understanding they build up through their practical work. It is important that students are able to apply these skills and this understanding to novel contexts in written exams. Teachers can vary all experiments to suit their needs.

Using set methods to assess students' competence for the endorsement

Students who are given a method that is fully developed, with full, clear instructions, will be able to demonstrate some competencies (eg following written instructions), but not others (eg researching and reporting).

We have developed 'ladders' which will help you to modify each of the given practicals to allow your students greater freedom to develop and demonstrate these wider practical skills. Each ladder identifies how slight modifications to the way the experiment is presented can change the focus of it and allow students to demonstrate more independence. In turn, they will allow you to be more confident in your judgement of student abilities for the endorsement of practical skills.

Investigation

Students do **not** need to carry out a full investigation. To achieve the endorsement, teachers must be confident that students can carry out practicals using 'investigative approaches'. In some practicals, teachers will wish to give full instructions for every stage in the activity. In other activities, teachers will give students some choice over how they carry out the activity, for example choosing the apparatus or the conditions for the experiment. On other occasions, teachers will wish to give students choice over how they analyse the data.

This approach means that students will be able to demonstrate all aspects of investigation over the A-level course without the practical problems associated with a full investigation.

Safety

At all times, the teacher is responsible for safety in the classroom. Teachers should intervene whenever they see unsafe working. Risk assessments should be carried out before working, and advice from CLEAPSS and other organisations should be followed.

It is appropriate to give students at A-level more independence when making decisions about safety. They should be taught how to assess risks and how to write risk assessments when appropriate. They should also understand the appropriate use of safety equipment and how to put measures in place to reduce risks.

To support teachers further, Mary Philpott, Biology Adviser, previously from CLEAPSS, outlines the difference between identification of major hazards, associated risk and control measures and a full risk assessment:

The risk assessment should always be complete, as it is this that prevents injury or ill-health.

The risk assessment is fundamentally the **thinking** that has taken place before and during an activity, so that any foreseeable risk is reduced to a minimum. A written record is necessary only to show that the thinking has taken place.

We tend to get caught up in the paperwork that provides evidence for the risk assessment, but the guidance from the Health and Safety Executive is that the written record should be on a **point-of-use document** and there is no particular form etc that needs to be filled in.

The tables/forms etc that many schools use are simply planning documents that the teachers use to provide the point of use risk assessment for each of their lessons. Incidentally, CLEAPSS members must refer to our current advice when preparing their point-of-use documents.

The student is not responsible for their risk assessment. In a large part, therefore, the student's risk assessment will be that they carry through the safety measures that the teacher has put in place. It is therefore fine if the student makes a note on their point-of use document that shows they have thought about how to behave safely, and carried it through. The teacher will also be able to record what they have seen in a practical that shows that the student's risk assessment is effective. For example, the student's written risk assessment could be as simple as making notes on a method sheet about where they will put on eye protection or how they will arrange any heating equipment so that there is a minimum risk of scalding or burning themselves or the person next to them.

The teacher's observation notes will refer to whether they have carried out their written plans.

It might help the students to think safely if the teacher gives them a little time at the start of each practical to highlight or make notes about the safety aspects, and a class discussion about safety could show up any safety aspects that perhaps the teacher had not considered.

The students may also note where they have reminded other students about any safety issues.

The teacher should pass the student's CPAC when the students are seen to carry out the safety measures that they have written on their point of use document.

If the students are planning their own practical activities, they could use the safety advice given in the [CLEAPSS Student Safety Sheets](#).

In this case, they could identify hazards, risks and control measures.

In this case, they would make their own point of use document, with the control measures clearly identified.

The teacher would need to check that the risk assessment is adequate before they let the students proceed with the activity.

These are examples of 12 experiments that can be done as part of the AS/A-level Physics course. The methods are written using commonly used reagents and techniques, although teachers can modify the methods and reagents as desired.

Trialling

All practicals should be trialled before use with students.

Risk assessment and risk management

Risk assessment and risk management are the responsibility of the centre.

Safety is the responsibility of the teacher and the centre. It is important that students are taught to act safely in the laboratory at all times, including the wearing of goggles at all times and the use of additional safety equipment where appropriate.

Notes from CLEAPSS

Technicians/teachers should follow CLEAPSS guidance, particularly that found on Hazcards and recipe sheets. The worldwide regulations covering the labelling of reagents by suppliers are currently being changed. Details about these changes can be found in leaflet GL101, which is available on the CLEAPSS website. You will need to have a CLEAPSS login.

Practical 1

Required practical	Investigation into the variation of the frequency of stationary waves on a string (or wire) with length, tension, and mass per unit length of string			
Apparatus and techniques covered (Relevant apparatus only, not full statements)	ATa. use appropriate analogue apparatus to record a range of measurements (to include length/distance) ATb. use appropriate digital instruments to obtain a range of measurements (to include mass) ATc. use methods to increase accuracy of measurements ATi. generate and measure waves using vibration transducer			
Indicative apparatus	For waves on a steel wire: Sonometer or 'soundbox' with steel wire(s) stretched over fixed and moveable bridges and pulley, set of 0.5 kg masses, metre ruler, balance, set of standard tuning forks with paper rider/resonance technique to measure frequency (or alternative electronic sensor for frequency measurement). Alternative method with strings or wires and suitable transducer (eg vibrator) for producing waves and measuring frequency, 100 g masses, balance, metre ruler.			
	Amount of choice			
	Increasing independence			
	Least choice	Some choice	Many choices	Full investigation
	Teacher gives students a full method with clear instructions as to how to set up the apparatus. All instruments and measurements are specified and students are instructed on the exact procedure and safety precautions.	Teacher allows students limited choice in identification and control of variables and range of readings. Otherwise all procedural techniques are specified.	Teacher indicates general method but student decides on measurement techniques and methodology, eg measurement of frequency.	Teacher indicates general line of enquiry at the end of a piece of work in which all separate techniques were seen and used by the student. Student decides on methodology and appropriate equipment and materials. All choices are justified with reference to experimental errors and safety.
Opportunities for observation and assessment of competencies				
Follow written procedures	✓✓✓ Students follow written method.	✓✓✓ Students follow written method.	✓✓✓ Students follow a method they have chosen.	✓✓✓ Students follow a method they have researched.
Applies investigative approaches	✓ Students correctly use the equipment and	✓✓ Students correctly use the equipment, carry	✓✓✓ Students select and correctly use the	✓✓✓ Student must choose an appropriate

and methods when using instruments and equipment	materials with minimum assistance and prompting.	out procedures methodically and make adjustments when necessary.	equipment, carry out procedures methodically and identify and control quantitative variables.	approach, equipment and techniques, identify quantitative variables for measurement and control.
Safely uses a range of practical equipment and materials	✓ Students must safely use the equipment following advice given.	✓✓ Students must safely use the equipment with minimal prompting.	✓✓✓ Students minimise risks in all aspects of the investigation with no prompting.	✓✓✓ Students must carry out a full risk assessment and minimise risks.
Makes and records observations	✓✓ Students record observations as specified in the method, and record in a methodical way using appropriate units and conventions.	✓✓✓ Students obtain accurate, precise and sufficient data and records this methodically using appropriate units and conventions.	✓✓✓ Students obtain accurate, precise and sufficient data and records this methodically using appropriate units and conventions.	✓✓✓ Students obtain accurate, precise and sufficient data and records this methodically using appropriate units and conventions.
Researches, references and reports	✓ Students process data in prescribed way and compare results with expected relationships.	✓✓ Students process data in prescribed way and compare results with expected relationships identifying potential discrepancies and errors.	✓✓ Students identify appropriate methods/tools to process data and compare with expected relationships, identifying potential errors and limitations.	✓✓✓ Students identify appropriate methods to process data, carry out research and report findings. Sources of information are cited together with supporting planning and conclusions.

✓✓✓: Very good opportunity ✓✓: Good opportunity ✓: Slight opportunity ✕: No opportunity

A-level Physics exemplar for required practical 1

Investigation into the variation of the frequency of stationary waves on a string with length, tension and mass per unit length of the string.

Teacher and technician sheet

This worksheet gives full details of the experiment, primarily for use by teachers and technicians who may be unfamiliar with the experiment. The worksheet would normally be adapted for student use to provide opportunity for students to make procedural decisions.

Materials and equipment

- signal generator
- vibration generator
- stand
- 2 kg mass
- 1.5 m length of string (eg 1.5 mm thick)
- pulley which can be clamped to the bench
- wooden bridge slightly higher than the pulley
- 100 g masses on a holder
- metre ruler
- an electronic top pan balance with precision 0.1 g or better.

Technical information

- The signal generator should be operated for about 20 minutes in order for the frequency to stabilise.
- The power output (eg 20 V peak-to-peak) should be used. The output level should be turned up to a value which gives steady vibrations of the vibration generator.
- The string should be tied to the stand and passed through the hole in the vibration generator.
- The bridge should be at the same height as the hole.
- The 2 kg mass is used as a counterweight to ensure the stand does not topple over (an alternative would be to clamp the stand to the bench using a G-clamp).

Photographs of an exemplar set-up of this practical can be found in our set-up guide, which is available on our [A-level Practicals page](#).

Sample results

The table below shows sample readings for a hanger of mass $m = 100 \text{ g}$ and the formula $v = 2fl$:

m = 100 g		
l / m	f / Hz	$v / \text{m s}^{-1}$
1.00	20.50	41.00
0.90	23.50	42.30
0.80	26.50	42.40
0.70	30.00	42.00
0.60	34.50	41.40
0.50	42.00	42.00

Using the formula $v = \sqrt{T/\mu}T$

$$T = 0.981 \text{ N} \quad m_{\text{string}} = 0.91 \text{ g} \quad l = 1.5 \text{ m}$$

$$\mu = m/l \quad \mu = 0.000607 \text{ kg m}^{-1}$$

$$\text{Then } v = 40.2 \text{ m s}^{-1}$$

Alternative practical

The AQA unit 3 EMPA (June 2013) will allow students to carry out an alternative practical without requiring a vibration generator and/or signal generator.

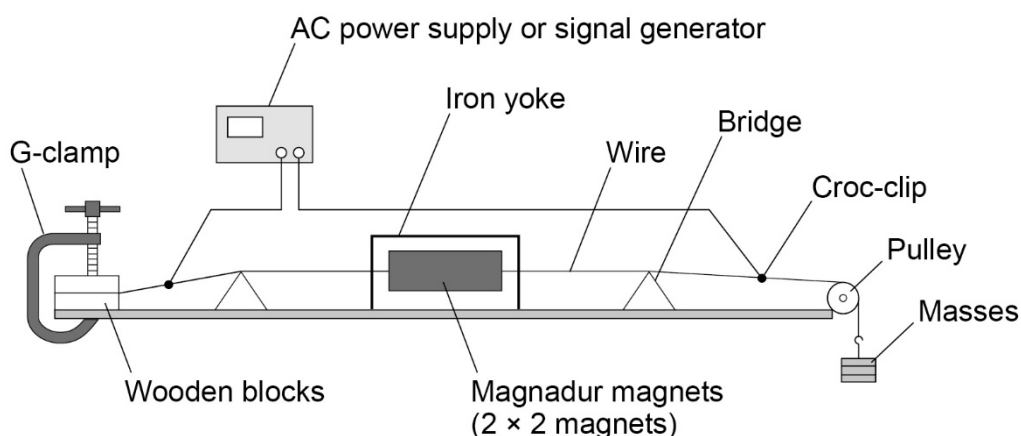

If signal generators are available, the vibration generators can be replaced by wire and magnadur magnets.

If the signal generator and the vibration generator are not available, AC power supply ($f = 50 \text{ Hz}$) can be used for the above arrangement and the task for the students could be to measure density of wire using standing waves.

Student sheet

Method

- Set up the apparatus as shown in the diagram.

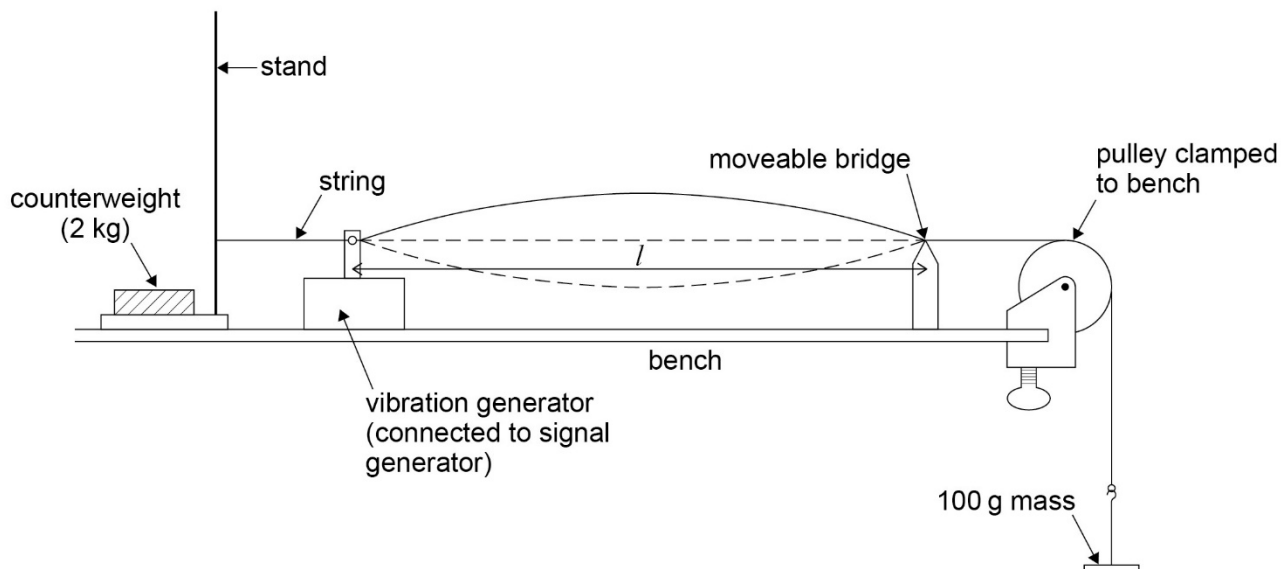

- Adjust the position of the bridge so that l is 1.000 m measured using the metre ruler.
- Increase the frequency of the signal generator from zero until the string resonates at its fundamental frequency (as indicated in the diagram with a node at each end and a central antinode).
- Read the frequency f , on the signal generator dial.
- Repeat the procedure with $l = 0.900, 0.800, 0.700, 0.600$ and 0.500 m.
- Obtain a second set of results by repeating the experiment and find the mean value of f for each value of l .
- Plot a graph of mean $1/f$ against l .
- Draw the best straight line of fit through the points and find the gradient (the graph should be a straight line through the origin).
- The speed of the travelling waves on the string is $v = f\lambda$ where λ is the wavelength. When the string is vibrating in its fundamental mode, $\lambda = 2l$. Hence $v = 2fl$. The gradient is $1/fl$ so v is given by $2/\text{gradient}$ in ms^{-1} .
- The speed is also given by $v = \sqrt{T/\mu}$ where T is the tension in the string in N and μ is the mass per unit length of the string in kg m^{-1} .
- With a 100 g mass hanging from the string, $T = 0.981$ N, μ can be found by weighing the 1.5 m length of string on an electronic balance, converting this into kg, and dividing by 1.5. These values can then be substituted into the above equation to find another value for v , which can be compared to the value obtained from the graph.
- The experiment can be repeated with different masses hanging from the string, and different thicknesses of string to investigate the effect of changing T and μ .
- Doubling the fundamental frequency while keeping l , T and μ constant will cause the string to resonate in its second harmonic (or first overtone, with nodes at either end, a central node, and two antinodes). Tripling the frequency will give the third harmonic, and so on.

Practical 2

Required practical		Investigation of interference in Young's slit experiment and diffraction by a diffraction grating.			
Apparatus and techniques covered (Relevant apparatus only, not full statements)		ATa. use appropriate analogue apparatus to record a range of measurements (to include length/distance, angle) ATj. use a laser or light source to investigate characteristics of light, including interference and diffraction			
Indicative apparatus		<p>Young's slits 'double slit' interference experiment: Laser (eg helium-neon laser), slide with 'double slit' (approximately 1 mm spacing), metre ruler, white screen (eg white paper attached to wall), stand with clamp/holder for 'double slit' (Alternative light source with single slit/double slit arrangement to produce coherent sources can be used instead of the laser, but this will usually require use of a dark room).</p> <p>Diffraction grating: Laser, plane transmission diffraction grating, stand with clamp/holder for diffraction grating, metre ruler, screen, (If available, the use of spectrometer with variety of different light sources, together with the diffraction grating is ideal).</p>			
		Amount of choice			
		Increasing independence 			
		Least choice	Some choice	Many choices	Full investigation
		Teacher gives students a full method with clear instructions as to how to set up the apparatus. All instruments and measurements are specified and students are instructed on the exact procedure and safety precautions.	Teacher allows students limited choice in the measurement of fringe width and angular position of the 'orders' of the diffraction pattern. Otherwise all procedural techniques are specified.	Teacher indicates general method for each experiment but student decides on range of readings, control of variables and measurement techniques for fringe width and angular position of the 'orders' of the diffraction pattern.	Teacher suggests general line of enquiry – to investigate interference and diffraction of light, including a double slit system and a diffraction grating. Student decides on methodology and appropriate equipment and materials. All choices are justified with reference to experimental errors and safety.
Opportunities for observation and assessment of competencies					
Follow written procedures	✓✓✓ Students follow written method.	✓✓✓ Students follow written method.	✓✓✓ Students follow a method they have chosen.	✓✓✓ Students follow a method they have researched.	

Applies investigative approaches and methods when using instruments and equipment	✓ Students correctly use the equipment and materials with minimum assistance and prompting.	✓✓ Students correctly use the equipment, carry out procedures methodically and make adjustments when necessary.	✓✓✓ Students correctly use the equipment, carry out procedures methodically and identify and control quantitative variables.	✓✓✓ Student must choose an appropriate approach, equipment and techniques, identify quantitative variables for measurement and control.
Safely uses a range of practical equipment and materials	✓ Students must safely use the equipment following advice given.	✓✓ Students must safely use the equipment with minimal prompting.	✓✓✓ Students minimise risks in all aspects of the investigation with no prompting.	✓✓✓ Students must carry out a full risk assessment and minimise risks.
Makes and records observations	✓✓ Students record observations as specified in the method, and record in a methodical way using appropriate units and conventions.	✓✓✓ Students obtain accurate, precise and sufficient data and records this methodically using appropriate units and conventions.	✓✓✓ Students obtain accurate, precise and sufficient data and records this methodically using appropriate units and conventions.	✓✓✓ Students obtain accurate, precise and sufficient data and records this methodically using appropriate units and conventions.
Researches, references and reports	✓ Students process data in prescribed way and compare results with expected relationships.	✓✓ Students process data in prescribed way and compare results with expected relationships identifying potential discrepancies and errors.	✓✓✓ Students identify appropriate methods/tools to process data and compare with expected relationships, identifying potential errors and limitations.	✓✓✓ Students identify appropriate methods to process data, carry out research and report findings. Sources of information are cited together with supporting planning and conclusions.

✓✓✓: Very good opportunity ✓✓: Good opportunity ✓: Slight opportunity ✕: No opportunity

A-level Physics exemplar for required practical 2

Investigation of the interference effects by Young's slit and diffraction by a diffraction grating.

Teacher and technician sheet

This worksheet gives full details of the experiment, primarily for use by teachers and technicians who may be unfamiliar with the experiment. The worksheet would normally be adapted for student use to provide opportunity for students to make procedural decisions.

Young's slit experiment

Materials and equipment

- laser – class II optical laser with output 1 mW or less
- darkened slide with double slit 'rulings' (usually 1 mm slit separation)
- vernier callipers to measure slit separation
- adjustable single slit (might be unnecessary with the laser)
- white screen (wall covered with white paper may be suitable but paper must be matt finish or non-reflective to reduce chances of reflected beams)
- metre ruler.

Technical information

Using a laser for this experiment makes it possible to produce visible interference fringes in a partially darkened laboratory. Ensure lasers are used safely and set up so they are not pointed directly into anyone's eyes.

Photographs of an exemplar set-up of this practical can be found in our set-up guide, which is available on our [A-level Practicals page](#).

Sample results

The table below shows sample readings for the Young double slit experiment:

$s = 0.1 \text{ mm}$		
D / m	w / mm	λ / nm
1.50	9.42	628.00
1.30	8.21	631.50
1.00	6.27	627.00
0.90	5.66	628.90
0.70	4.44	634.30
0.50	3.11	622.00

Student sheet

Method

- A partially darkened laboratory is required ensuring lasers are used safely.
- Set up the apparatus as shown in the diagram, with the laser illuminating the double slit and the screen a distance D of initially about 1 metre. (With the laser the single slit might not be required, provided the laser beam is wide enough to illuminate across the double slit).

Plan view

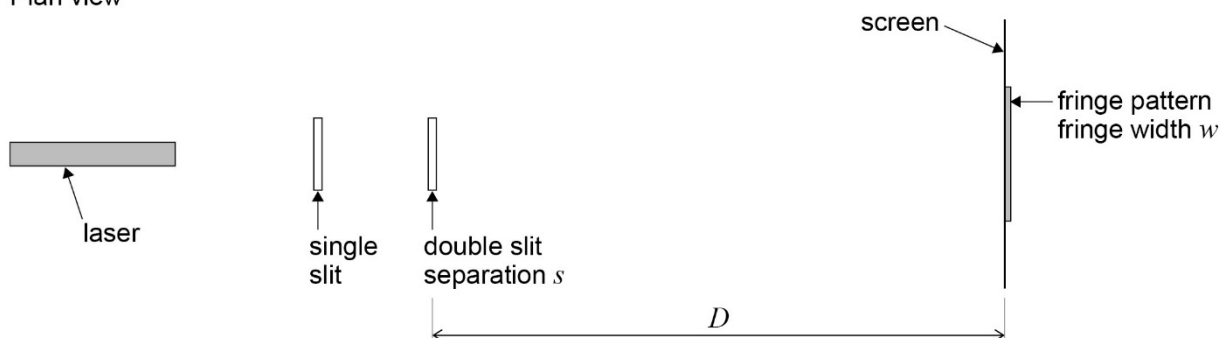

- Carefully adjust the position of the laser until the light spreads evenly over the two slits. An interference pattern should be visible on the screen.
- The fringe width (or fringe spacing), w , can be measured by measuring across a large number of visible fringes. (Take care when counting – counting from the first bright fringe to the tenth bright fringe would represent nine fringe widths!).
- Use the metre ruler to measure D .
- A measurement of the slit separation, s , is required. The value could be measured with vernier callipers or travelling microscope. If a travelling microscope is used it must only be used to measure slit separation and **not the fringe width**. Alternatively the manufacturer may quote the value on the slide.
- Use the equation $\lambda = \frac{w s}{D}$
- Alternatively, the value of D could be changed from approximately 0.5 m to 1.5 m and the fringe width, w , measured for each value of D .
- A graph of w on the y -axis against D should be a straight line through the origin, with gradient $= \lambda / s$.

Diffraction with a plane transmission diffraction grating at normal incidence.

Teacher and technician sheet

Materials and equipment

- laser – class II optical laser with output 1 mW or less
- plane transmission diffraction grating
- white screen (wall covered with white paper may be suitable but paper must be matt finish or non-reflective to reduce chances of reflected beams)
- metre ruler.

Photographs of an exemplar set-up of this practical can be found in our set-up guide, which is available on our [A-level Practicals page](#).

Sample results

The table below shows sample readings for the diffraction grating experiment:

$D = 1.09 \text{ m}$			
n	h / mm	$\tan \theta$	λ / nm
1	68.20	0.06	624.50
2	138.40	0.13	629.80
3	208.60	0.19	626.60
4	282.40	0.26	627.00

Student sheet

Method

- A partially darkened laboratory is required. Please ensure lasers are used safely.
- Set up the apparatus as shown in the diagram, with the laser illuminating the diffraction grating and the screen a distance D of initially about 1 metre.

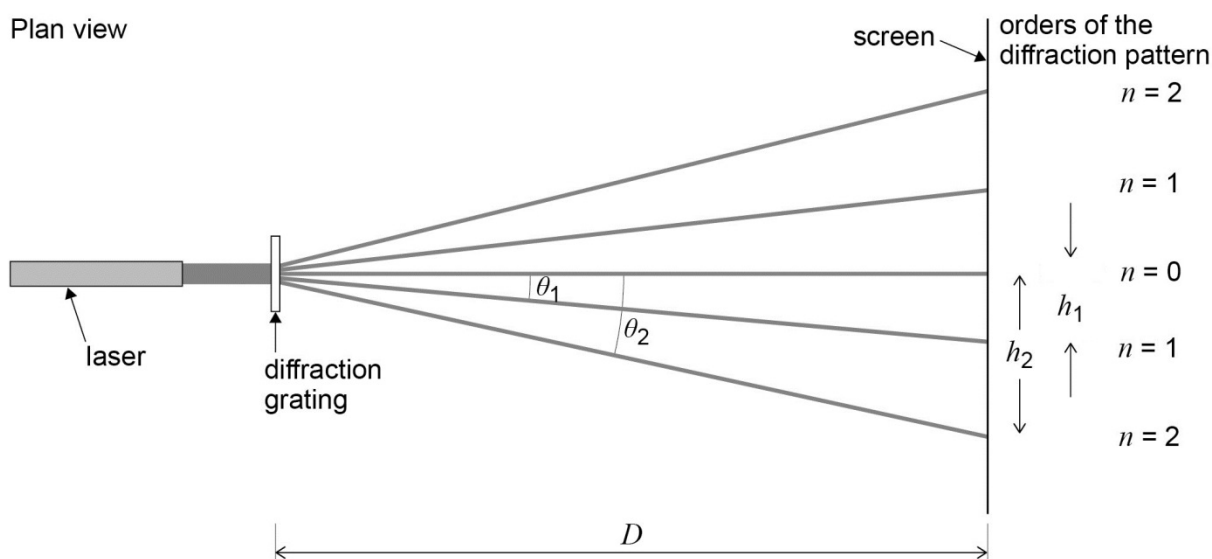

- Carefully adjust the position of the diffraction grating so that the diffraction grating is perpendicular to the beam of light from the laser. (A large set square might be useful).
- The diffraction pattern should be visible on the screen. The number of orders shown will depend on the line spacing of the diffraction grating.
- The angles θ_1 and θ_2 can be determined by measuring the distances h_1 , h_2 and D . (This gives the tangent of the angles, and hence the angles can be calculated).
- The formula $n\lambda = d \sin\theta$ can be used to determine the wavelength of the laser light.
 - n is the order of the diffraction pattern
 - d is the grating spacing = 1/number of lines per metre
 - λ is the wavelength of light
- The values of θ for each order, both above and below the zero order, should be measured. A mean value for λ can be calculated from the data.

Single slit diffraction

This arrangement can also be used to illustrate diffraction at a single slit. The diffraction grating is replaced by an adjustable single slit. The effect of 'slit width' can easily be observed.

Practical 3

Required practical		Determination of g by a free-fall method			
Apparatus and techniques covered (Relevant apparatus only, not full statements)	ATa. use appropriate analogue apparatus to record a range of measurements (to include length/distance) ATc. use methods to increase accuracy of measurements ATd. use of light gates for timing ATk. use of ICT – Data logger with light gates and data processing software (capable of measurement of time, velocity and/or acceleration directly)				
Indicative apparatus	Light gates, data logger, computer, stand boss and clamp for light gates, rectangular laminar (or other suitable object to drop through the light gates), metre ruler. (Alternative method using centi-second timer, steel ball bearing, electromagnet and impact switch is also acceptable).				
		Amount of choice			
		Increasing independence 			
		Least choice	Some choice	Many choices	Full investigation
		Teacher gives students a full method with clear instructions as to how to set up the apparatus. All instruments and measurements are specified and students are instructed on the exact procedure and safety precautions.	Teacher allows students limited choice in use of light gates and range of heights. Otherwise all procedural techniques are specified.	Teacher suggests outline method, using light gates, to measure g by a free-fall method. Student decides range of readings and suitable 'freefall object' based on preliminary experiment. Student also makes decisions on the processing of data together with the use of the data processing software.	At the end of a piece of work on dynamics, where the student has had experience using all relevant practical techniques, teacher sets the problem of devising an accurate method to measure g . Student makes full decision about methodology, equipment and materials. All choices are fully justified with reference to experimental errors and safety.
Opportunities for observation and assessment of competencies					
Follow written procedures	✓✓✓ Students follow written method.	✓✓✓ Students follow written method.	✓✓✓ Students follow a method they have chosen.	✓✓✓ Students follow a method they have researched.	
Applies investigative approaches and methods	✓ Students correctly use the equipment and materials with	✓✓ Students correctly use the equipment, carry out procedures	✓✓ Students select and correctly use the equipment, carry	✓✓✓ Student must choose an appropriate approach,	

when using instruments and equipment	minimum assistance and prompting.	methodically and make adjustments when necessary.	out procedures methodically and identify and control quantitative variables.	equipment and techniques, identify quantitative variables for measurement and control.
Safely uses a range of practical equipment and materials	✓ Students must safely use the equipment following advice given.	✓✓ Students must safely use the equipment with minimal prompting.	✓✓✓ Students minimise risks in all aspects of the investigation with no prompting.	✓✓✓ Students must carry out a full risk assessment and minimise risks.
Makes and records observations	✓✓ Students record observations as specified in the method, and record in a methodical way using appropriate units and conventions.	✓✓✓ Students obtain accurate, precise and sufficient data and records this methodically using appropriate units and conventions.	✓✓✓ Students obtain accurate, precise and sufficient data and records this methodically using appropriate units and conventions.	✓✓✓ Students obtain accurate, precise and sufficient data and records this methodically using appropriate units and conventions.
Researches, references and reports	✓ Students process data in prescribed way and compare results with expected relationships.	✓✓ Students process data in prescribed way and compare results with expected relationships identifying potential discrepancies and errors.	✓✓ Students identify appropriate methods/tools to process data and compare with expected relationships, identifying potential errors and limitations.	✓✓✓ Students identify appropriate methods to process data, carry out research and report findings. Sources of information are cited together with supporting planning and conclusions.

✓✓✓: Very good opportunity ✓✓: Good opportunity ✓: Slight opportunity ✗: No opportunity

A-level Physics exemplar for required practical 3

Determination of g by a free-fall method.

Teacher and technician sheet

This worksheet gives full details of the experiment, primarily for use by teachers and technicians who may be unfamiliar with the experiment. The worksheet would normally be adapted for student use to provide opportunity for students to make procedural decisions.

Materials and equipment

- stand and clamp
- electromagnet
- low voltage variable DC supply (to power the electromagnet)
- 2 kg mass
- steel ballbearing
- two light gates with bosses to attach them to the stand
- an electronic clock or data logger with precision 1 ms or better.
- a pad (eg of felt) to protect the bench when the ballbearing lands.
- metre ruler.

Technical information

- The electromagnet is a convenient way of releasing the ballbearing.
- The low voltage supply should be set at the voltage specified by the manufacturer for the electromagnet.
- The supply is switched on and the ballbearing hung from the electromagnet. It will then be released when the supply is switched off.
- Several trials and adjustments will be required to ensure the ballbearing falls directly through the light gates. A plumb line can be used to make sure that the ball bearing will fall through both light gates and hit the pad.
- A mechanical release mechanism could be used (eg holding the ballbearing in the clamp which is opened to release the ball bearing, but this is not as quick to reset, and won't give as clean a release).
- The upper light gate should be connected to the clock or data logger to start the timing.
The lower gate should be connected to stop the timing.
- The 2 kg mass is used as a counterweight to ensure the stand does not topple over (an alternative would be to clamp the stand to the bench using a G-clamp).

Photographs of an exemplar set-up of this practical can be found in our set-up guide, which is available on our [A-level Practicals page](#).

Additional note

If students have no access to light gates, they can use the same method but with a slightly different arrangement of apparatus:

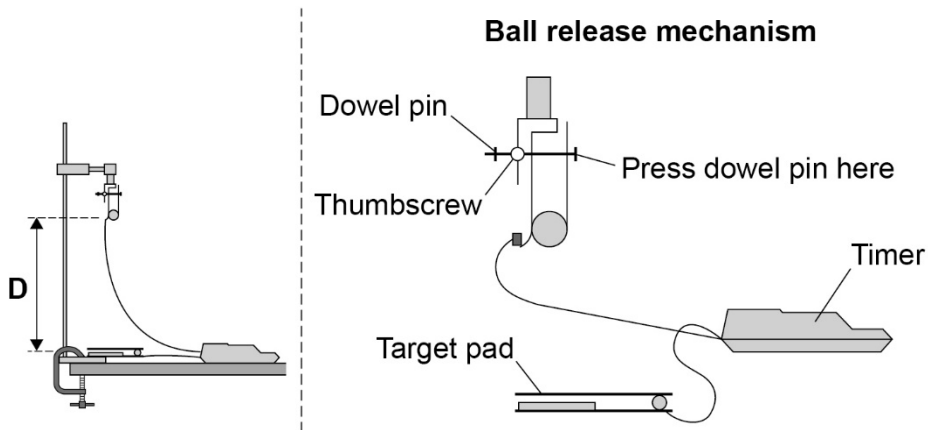

Once the ball bearing is released, the stopclock starts measuring the time. When the ball bearing hits the pad, it triggers the micro switch and stops the stopclock.

Sample results

The table below shows sample readings for 'g' by free fall:

h / m	t / s	$g / \text{m s}^{-2}$
1.35	0.50	10.80
1.10	0.45	10.90
0.85	0.40	10.60
0.65	0.35	10.60

Student sheet

Method

- Set up the apparatus as shown in the diagram.

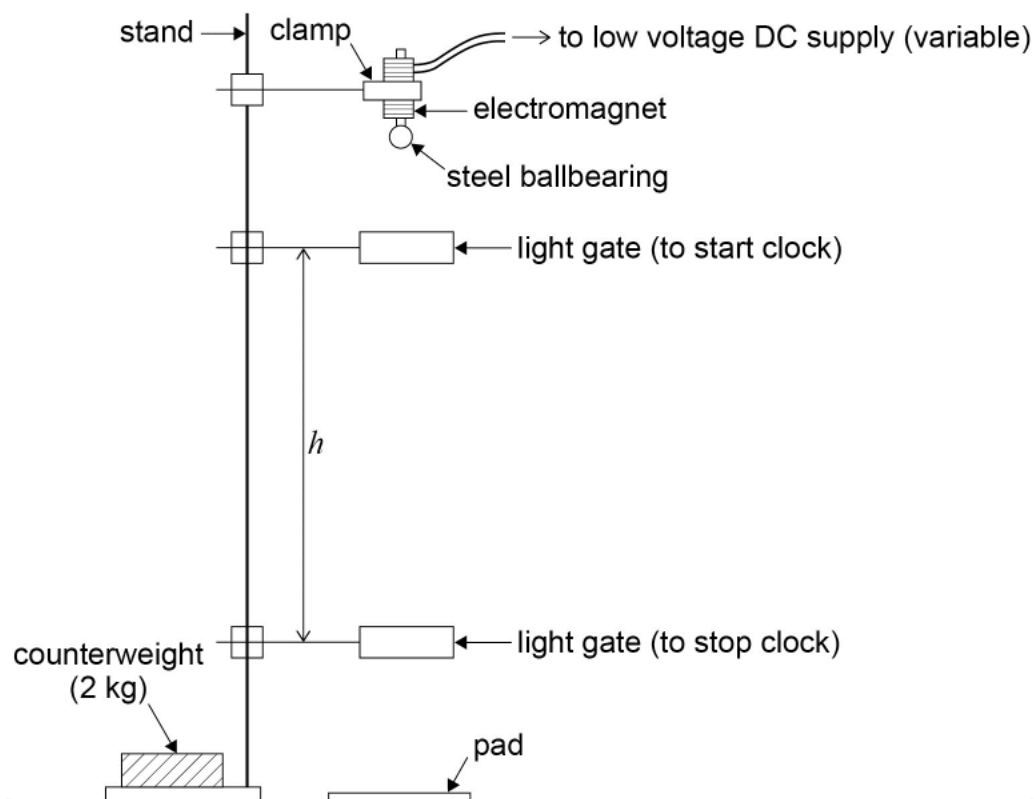

- The height between the starting position of the ballbearing and the upper light gate should be kept constant, so that the velocity, u , with which the ballbearing reaches this light gate is also constant.
- Adjust the position of the lower light gate so that h is 0.500 m measured using the metre ruler (If a taller stand is available, h could be set at a higher starting value).
- Switch on the supply to the electromagnet, and hang the ballbearing from it (or fit the ballbearing into the clamp if a mechanical release mechanism is being used).
- Reset the clock or data logger to zero and switch off the electromagnet (or open the clamp).
- Read the time on the clock or data logger once the ballbearing has passed through the light gates.
- Take repeat readings to find the mean time, t .
- Reduce h by 0.050 m and repeat the procedure down to a value of 0.250 m (lower values than this make it difficult to obtain accurate timings).
- Plot a graph of $2h/t$ against t .

-
- Draw the best straight line of fit through the points and find the gradient (the graph should be a straight line with intercept $2u$).

$$h = ut + \frac{gt^2}{2}$$

Re-arranging

$$2h/t = gt + 2u$$

Hence the gradient of the graph gives g in ms^{-2}

The intercept will be $2u$.

Practical 4

Required practical		Determination of the Young Modulus by a simple method			
Apparatus and techniques covered (Relevant apparatus only, not full statements)	ATa. use appropriate analogue apparatus to record a range of measurements (to include length/distance) ATc. use methods to increase accuracy of measurements ATe. use of micrometers for small distances, using digital or vernier scales				
	Indicative apparatus For a steel wire suspended vertically: Suitable (ceiling) suspension point or beam from which loaded test wire can be suspended, clamps to attach wires to supporting beam, suitable test wire (eg steel wire approximately 0–5 mm diameter) and identical ‘comparison’ wire, mm scale with sliding vernier scale (scale with vernier is specially designed for this experiment - with clamps for the main scale to attach to the comparison wire and similar clamps on the vernier which attach to the test wire), set of 0.5 kg or 1 kg slotted masses and mass hanger for test wire, mass hanger and one 0.5 kg mass for comparison wire, metre ruler, micrometer screw gauge. Alternative method with test wire stretched horizontally across a bench: G – clamp and wooden blocks to clamp the test wire, metre ruler, test wire (eg copper wire diameter approximately 0.5 mm), set of 100 g slotted masses and mass hanger, bench pulley (which has clamp to attach to work bench), micrometer screw gauge, set square/marker to attach to wire/vernier scale to measure extension of wire.				
		Amount of choice			
		Increasing independence			
		Least choice	Some choice	Many choices	Full investigation
		Teacher gives students a full method with clear instructions as to how to set up the apparatus. All instruments and measurements are specified and students are instructed on the exact procedure and safety precautions.	Teacher allows students limited choice of method to measure the diameter of the wire and the extension of the loaded wire. Otherwise all procedural techniques are specified.	Teacher suggests outline method to determine the Young Modulus by measuring the extension of a loaded wire. Students decide on in most appropriate measuring instruments and suitable range of masses after preliminary experiment.	Teacher suggests link between the extension of a loaded stretched metal wire and the dimensions of the wire. Student makes full decision about methodology, equipment and materials. All choices are fully justified with reference to experimental errors and safety.

Opportunities for observation and assessment of competencies				
Follow written procedures	✓✓✓ Students follow written method.	✓✓✓ Students follow written method.	✓✓✓ Students follow a method they have chosen.	✓✓✓ Students follow a method they have researched.
Applies investigative approaches and methods when using instruments and equipment	✓ Students correctly use the equipment and materials with minimum assistance and prompting.	✓✓ Students correctly use the equipment, carry out procedures methodically and make adjustments when necessary.	✓✓✓ Students select and correctly use the equipment, carry out procedures methodically and identify and control quantitative variables.	✓✓✓ Student must choose an appropriate approach, equipment and techniques, identify quantitative variables for measurement and control.
Safely uses a range of practical equipment and materials	✓ Students must safely use the equipment following advice given.	✓✓ Students must safely use the equipment with minimal prompting.	✓✓✓ Students minimise risks in all aspects of the investigation with no prompting.	✓✓✓ Students must carry out a full risk assessment and minimise risks.
Makes and records observations	✓✓ Students record observations as specified in the method, and record in a methodical way using appropriate units and conventions.	✓✓✓ Students obtain accurate, precise and sufficient data and records this methodically using appropriate units and conventions.	✓✓✓ Students obtain accurate, precise and sufficient data and records this methodically using appropriate units and conventions.	✓✓✓ Students obtain accurate, precise and sufficient data and records this methodically using appropriate units and conventions.
Researches, references and reports	✓ Students process data in prescribed way and compare results with expected relationships.	✓✓ Students process data in prescribed way and compare results with expected relationships identifying potential discrepancies and errors.	✓✓ Students identify appropriate methods/tools to process data and compare with expected relationships, identifying potential errors and limitations.	✓✓✓ Students identify appropriate methods to process data, carry out research and report findings. Sources of information are cited together with supporting planning and conclusions.

✓✓✓: Very good opportunity ✓✓: Good opportunity ✓: Slight opportunity *: No opportunity

A-level Physics exemplar for required practical 4

Determination of the Young Modulus by a simple method.

Teacher and technician sheet

This worksheet gives full details of the experiment, primarily for use by teachers and technicians who may be unfamiliar with the experiment. The worksheet would normally be adapted for student use to provide opportunity for students to make procedural decisions.

Materials and equipment

- ceiling beam or suitably strong fixing to attach loaded wires
- 2 × 1.5 m lengths of steel wire (eg 0.45 mm diameter mild steel wire)
- scale and vernier arrangement with integral clamps for the wires
- micrometer screw gauge
- metre ruler
- 2 × slotted kg mass holders
- selection of 0.5 kg and 1 kg slotted masses
- safety goggles (in case wire breaks)
- sand tray (to catch masses if wire breaks).

Technical information

- It is important that the steel wire used is completely free from kinks – otherwise any measured ‘extension’ will partly be due to the straightening out of the kinks. Scientific equipment suppliers produce suitable wires for this experiment. They also supply suitable clamps to attach the wires to the ceiling beam, vernier-scale arrangement and mass holder.
- A 1 kg mass will produce an extension of 0.47 mm for a 1.5 m steel wire of diameter 0.45 mm. Consequently an accurate measurement of extension requires specialised apparatus. The mm scale and vernier arrangement is one designed specifically for this experiment – the vernier is attached to, and slides alongside the main scale. The main mm scale is usually clamped to the comparison wire and the vernier section clamped to the test wire.
- The main safety consideration is the possibility of the wire breaking. Goggles should be worn and a sand tray placed underneath the arrangement to catch the falling masses.
- The comparison wire compensates for sagging of the beam and thermal expansion effects, and provides a reference point against which to measure the extension of the loaded test wire.

Photographs of an exemplar set-up of this practical can be found in our set-up guide, which is available on our [A-level Practicals page](#).

Additional notes

- When stretching a wire horizontally, Tippex or a small dressmaker pin could be used as a marker.
- For the horizontal version of the experiment, use 2 m of 32SWG copper wire (400 g mass should produce an extension of about 1 mm).

Searle's apparatus is very precise, but sometimes there is not enough room in the classroom to install a full class set. Similar results could be achieved using a horizontal version and traveling microscope, as shown below. If traveling microscopes are not available, high precision rulers could be used (0.5 mm precision).

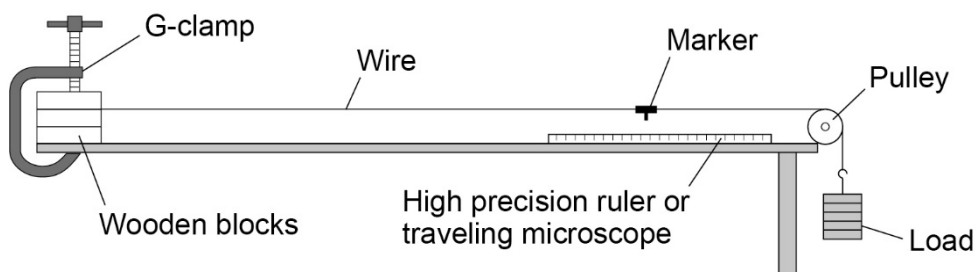

Sample results

The table below sample readings for a wire stretched horizontally across a bench using a traveling microscope.

	$L = 2.4 \text{ m}$		$d = 0.274 \text{ mm}$					
m / kg	0.200	0.400	0.600	0.800	1.000	1.200	1.400	1.600
$\Delta L / \text{mm}$	0.5	1.0	1.6	2.1	2.7	3.5	4.0	5.0
E / GPa	133.2	133.2	124.8	126.8	123.3	114.1	116.5	106.5

Student sheet

Method

- Set up the apparatus as shown in the diagram. Ensure all the wire clamps are fully tightened.
Details of wire clamps **not** shown on this diagram

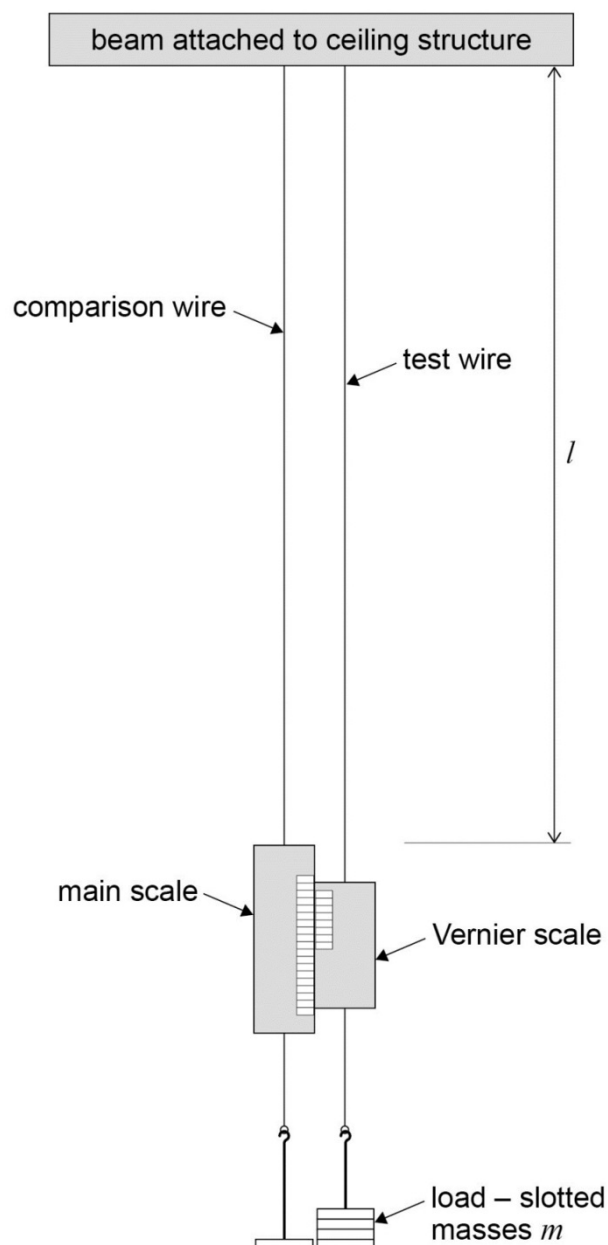

- Measure the initial length of the test wire, l , with the metre ruler.
- A 1 kg mass hanger is initially attached to each wire, to ensure both wires are initially stretched taut.

- Take the initial scale reading, using the vernier scale to read to 0.1 mm.
- Add an additional 1 kg (or 0.5 kg) mass to the test wire and take the new scale reading using the vernier. The extension of the wire can be calculated by subtracting the two scale readings.
- Repeat the process, adding an extra 1 kg mass (or 0.5 kg) mass each time, take the new scale reading and calculate the corresponding extension. A total mass of up to 8 kg should be adequate.
- With the wire full loaded remove a 1 kg mass and take the scale reading.
- Continue to unload the wire, 1 kg at a time, taking the scale reading each time.
- The extension of the wire for each mass during the unloading process can then be calculated. If the extension during unloading is greater than during loading, the elastic limit for the wire might have been exceeded. If the extension values are similar a mean extension for loading /unloading can be calculated for each mass.
- Measure the diameter of the wire at several places using a micrometer screw gauge.
- Plot a graph of mean extension, e , on the y -axis against load, mg . (where $g = 9.81 \text{ N/kg}$)
- The Young Modulus for the material of the wire (steel) can be calculated using the gradient of the graph.
- Estimate the uncertainty in your values of l , A , e and m . Use the values to estimate the overall uncertainty in the value obtained for Young's Modulus.

$$\text{Young modulus } E = \frac{\text{tensile stress}}{\text{tensile strain}} = \frac{mg/A}{e/L} = \frac{mgL}{Ae} = \frac{L}{A \times \text{gradient}}$$

A = cross sectional area of wire

L = initial length of wire

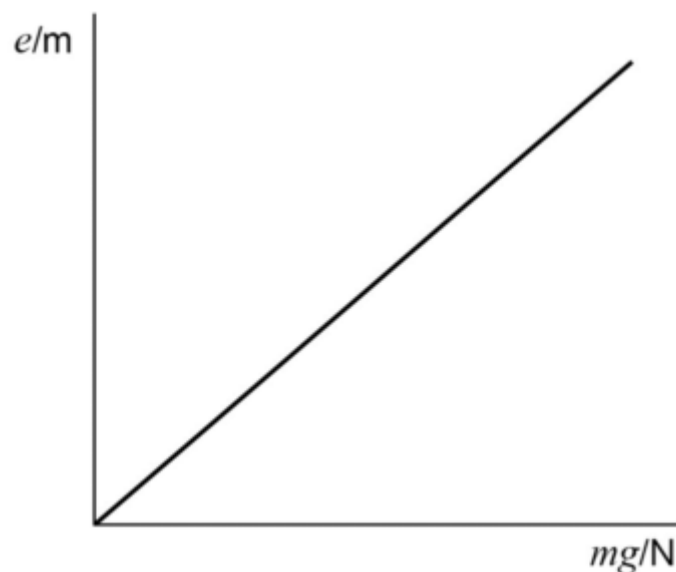

Practical 5

Required practical	Determination of the resistivity of a wire using a micrometer screw gauge, ammeter and voltmeter.			
Apparatus and techniques covered (Relevant apparatus only, not full statements)	ATa. use appropriate analogue apparatus to record a range of measurements (to include length/distance) ATb. use appropriate digital instruments, including electrical multimeters, to obtain a range of measurements (to include current, voltage, resistance) ATe. use micrometers for small distances, using digital or vernier scales ATf. correctly construct circuits from circuit diagrams using DC power supplies, cells, and a range of circuit components ATg. design, construct and check circuits using DC power supplies, cells, and a range of circuit components			
Indicative apparatus	DC power supply or cells, rheostat/potential divider (or other means of adjusting current/pd), connecting leads, micrometer screw gauge, metre ruler, ammeter, voltmeter, selection of different swg resistance wire (eg constantan wire).			
	Amount of choice			
	Increasing independence			
	Least choice	Some choice	Many choices	Full investigation
	Teacher gives students a full method with clear instructions/circuit diagram as to how to set up the circuit. All instruments, including ranges, are specified and students are instructed as to suitable lengths/gauges of resistance wire to use.	Teacher allows a limited choice of lengths/gauges of resistance wire to use, and also allows students to choose an appropriate instrument to measure the diameter of the wire(s). Other details of experiment fully specified.	Teacher suggests outline method to determine resistivity by measuring resistance of wire but does not provide a circuit diagram. Students decide on instruments (and ranges), and the gauge and length of resistance wire used after preliminary experiment.	Teacher suggests link between resistance and dimensions of a metal. Student makes full decision about methodology, equipment and materials. All choices are fully justified with reference to experimental errors and safety.
Opportunities for observation and assessment of competencies				
Follow written procedures	✓✓✓ Students follow written method.	✓✓✓ Students follow written method.	✓✓✓ Students follow a method they have chosen.	✓✓✓ Students follow a method they have researched.

Applies investigative approaches and methods when using instruments and equipment	✓ Students correctly use the equipment and materials with minimum assistance and prompting.	✓✓ Students correctly use the equipment, carry out procedures methodically and make adjustments when necessary.	✓✓✓ Students select and correctly use the equipment, carry out procedures methodically and identify and control quantitative variables.	✓✓✓ Student must choose an appropriate approach, equipment and techniques, identify quantitative variables for measurement and control.
Safely uses a range of practical equipment and materials	✓ Students must safely use the equipment following advice given.	✓✓ Students must safely use the equipment with minimal prompting.	✓✓✓ Students minimise risks in all aspects of the experiment with no prompting.	✓✓✓ Students must carry out a full risk assessment and minimise risks.
Makes and records observations	✓✓ Students record observations as specified in the method, and record in a methodical way using appropriate units and conventions.	✓✓✓ Students obtain accurate, precise and sufficient data and records this methodically using appropriate units and conventions.	✓✓✓ Students obtain accurate, precise and sufficient data and records this methodically using appropriate units and conventions.	✓✓✓ Students obtain accurate, precise and sufficient data and records this methodically using appropriate units and conventions.
Researches, references and reports	✓ Students process data in prescribed way and compare results with expected values.	✓✓ Students process data in prescribed way and compare results with expected values identifying potential discrepancies and errors.	✓✓ Students identify appropriate methods/tools to process data and compare with expected values, identifying potential discrepancies and errors.	✓✓✓ Students identify appropriate methods to process data, carry out research and report findings. Sources of information are cited together with supporting planning and conclusions.

✓✓✓: Very good opportunity ✓✓: Good opportunity ✓: Slight opportunity ✕: No opportunity

A-level Physics exemplar for required practical 5

Determination of resistivity of a wire using a micrometer, ammeter and voltmeter.

Teacher and technician sheet

This worksheet gives full details of the experiment, primarily for use by teachers and technicians who may be unfamiliar with the experiment. The worksheet would normally be adapted for student use to provide opportunity for students to make procedural decisions.

Materials and equipment

- 1 metre length of constantan wire of thickness 0.25 mm, for example
- low voltage variable DC supply (eg 0–6 V)
- ammeter (eg 0–1 A with 0.02 A precision or better)
- voltmeter (eg 0–5 V with 0.1 V precision or better)
- two crocodile clips
- five connecting leads
- metre ruler
- micrometer.

Technical information

- The constantan wire should be free from kinks and held as straight as possible when measuring the length.
- The thickness of 0.25 mm has been suggested as this is sufficiently large to measure accurately with the micrometer.
- A 10 cm length of it will have a resistance of around 1 Ω , which will allow a reasonably accurate determination of its resistance.
- Mounting 2 × 4 mm terminals at both ends of the meter ruler will allow easier wire length measurements.

Photographs of an exemplar set-up of this practical can be found in our set-up guide, which is available on our [A-level Practicals page](#).

Sample results

The table below shows sample readings for 22SWG constantan wire:

22SWG							
V/V	1.48	1.77	1.87	2.25	2.42	2.51	2.63
I/A	5.87	4.80	3.68	3.55	3.34	2.96	2.78
l/m	0.2	0.3	0.4	0.5	0.6	0.7	0.8
$\rho/\Omega m$	4.85×10^{-7}	4.73×10^{-7}	4.89×10^{-7}	4.88×10^{-7}	4.64×10^{-7}	4.66×10^{-7}	4.55×10^{-7}

Student sheet

Method

- Measure the thickness of the constantan wire using the micrometer in at least 3 places and find the mean diameter d . Convert this to metres.
- Set up the apparatus as shown in the diagram.

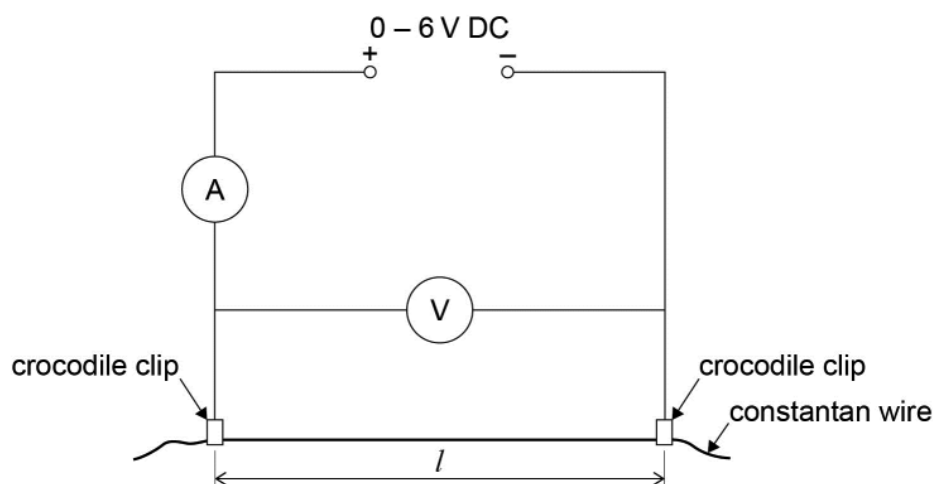

- Attach the crocodile clips so that $l = 0.100$ m measured on the meter ruler.
- Set the voltage, V , to 0.5 V and measure the current, I in A.
- Calculate the resistance $R = V/I$ in Ω
- Repeat the procedure for $l = 0.200, 0.300, 0.400, 0.500, 0.600, 0.700$ and 0.800 m, increasing V by 0.5 V each time to maintain the current at about 0.5 A. (This will allow a reasonably accurate measurement of the current, without it being so large that the wire is warmed, which may change its resistance. Switching off the power supply between readings will also keep any heating to a minimum)
- Obtain a second set of results by repeating the experiment and find the mean value of R for each value of l .
- Plot a graph of the mean R against l .
- Draw the best straight line of fit through the points and find the gradient (the graph should be a straight line through the origin).
- Calculate the cross-sectional area of the wire $A = \pi d^2/4$ in m^2 .

The resistivity of constantan is then

$$\rho = \frac{RA}{l}$$

The gradient of the graph gives R/l so

$$\rho = \text{gradient} \times A \text{ in } \Omega\text{m (the accepted value is } 4.9 \times 10^{-7} \Omega\text{m).}$$

Practical 6

Required practical	Investigation of emf and internal resistance of electric cells and batteries by measuring the variation of the terminal pd of the cell with current in it			
Apparatus and techniques covered (Relevant apparatus only, not full statements)	ATb. use of digital instruments, including ammeters, voltmeters and/or electrical multimeters ATf. correctly construct circuits from circuit diagrams using DC power supplies, cells and a range of circuit components, including those where polarity is important ATg. design, construct and check circuits using DC power supplies, cells, and a range of circuit components			
Indicative apparatus	Selection of cells with cell holders, variable resistor (or selection of fixed resistors), digital ammeter, digital voltmeter (or digital multimeter for measurement of current and/or pd), connecting leads, switch (or alternative method of disconnecting the circuit).			
	Amount of choice			
	Increasing independence			
	Least choice	Some choice	Many choices	Full investigation
	Teacher gives students a full method with circuit diagram and clear instructions as to how to set up the apparatus. All instruments and measurements are specified and students are instructed on the exact procedure and safety precautions.	Teacher allows students limited choice of range of current/pd readings. Otherwise circuit diagram is provided and all procedural techniques are specified.	Teacher suggests outline method, by investigating variation of pd across a cell/battery with current through it, but does not provide a circuit diagram. Students decide on most appropriate measuring instruments, ranges and resistor values, after preliminary experiment.	Teacher suggests general line of enquiry at the end of a piece of work where the student has had the opportunity to investigate, design and make measurements in a variety of other dc circuits. Student makes full decision about methodology, equipment and materials. All choices are fully justified with reference to experimental errors and safety.
Opportunities for observation and assessment of competencies				
Follow written procedures	✓✓✓ Students follow written method.	✓✓✓ Students follow written method.	✓✓✓ Students follow a method they have chosen.	✓✓✓ Students follow a method they have researched.

Applies investigative approaches and methods when using instruments and equipment	✓ Students correctly use the equipment and materials with minimum assistance and prompting.	✓✓ Students correctly use the equipment, carry out procedures methodically and make adjustments when necessary.	✓✓✓ Students select and correctly use the equipment, carry out procedures methodically and identify and control quantitative variables.	✓✓✓ Student must choose an appropriate approach, equipment and techniques, identify quantitative variables for measurement and control.
Safely uses a range of practical equipment and materials	✓ Students must safely use the equipment following advice given.	✓✓ Students must safely use the equipment with minimal prompting.	✓✓✓ Students minimise risks in all aspects of the investigation with no prompting.	✓✓✓ Students must carry out a full risk assessment and minimise risks.
Makes and records observations	✓✓ Students record observations as specified in the method, and record in a methodical way using appropriate units and conventions.	✓✓✓ Students obtain accurate, precise and sufficient data and records this methodically using appropriate units and conventions.	✓✓✓ Students obtain accurate, precise and sufficient data and records this methodically using appropriate units and conventions.	✓✓✓ Students obtain accurate, precise and sufficient data and records this methodically using appropriate units and conventions.
Researches, references and reports	✓ Students process data in prescribed way and compare results with expected relationships.	✓✓ Students process data in prescribed way and compare results with expected relationships identifying potential discrepancies and errors.	✓✓ Students identify appropriate methods/tools to process data and compare with expected relationships, identifying potential errors and limitations.	✓✓✓ Students identify appropriate methods to process data, carry out research and report findings. Sources of information are cited together with supporting planning and conclusions.

✓✓✓: Very good opportunity ✓✓: Good opportunity ✓: Slight opportunity ✗: No opportunity

A-level Physics exemplar for required practical 6

Investigation of the emf and internal resistance of electric cells and batteries.

Teacher and technician sheet

This worksheet gives full details of the experiment, primarily for use by teachers and technicians who may be unfamiliar with the experiment. The worksheet would normally be adapted for student use to provide opportunity for students to make procedural decisions.

Materials and equipment

- cell or battery whose internal emf and internal resistance is being investigated. Avoid using rechargeable cells or batteries as these have a very low internal resistance, making it difficult to measure and they can deliver high currents or short circuit
- Cell holder (or suitable connectors for cell/battery used)
- variable resistor (eg a large wire wound rheostat is suitable)
- digital voltmeter (eg 0–10 V)
- digital ammeter (eg 0–1 A)
- switch
- connecting leads.

Technical information

- Ideally the cells and/or batteries used should be fairly new. The emf and internal resistance of older, 'run down', cells will vary during the experiment. It is advisable to switch off the circuit between readings to avoid the cells/batteries running down.
- Ensure that the power rating of the variable resistor is adequate for the maximum current used.

Photographs of an exemplar set-up of this practical can be found in our set-up guide, which is available on our [A-level Practicals page](#).

Sample results

The table below shows sample readings for a 1.5 V D-cell with rheostat set to minimum and maximum resistance.

V / V	I / mA
1.58	70.00
1.52	180.00

So EMF = 1.62 V and $r = 0.54 \Omega$

Student sheet

Method

- Set up the circuit as shown in the diagram. Set the variable resistor at its maximum value.

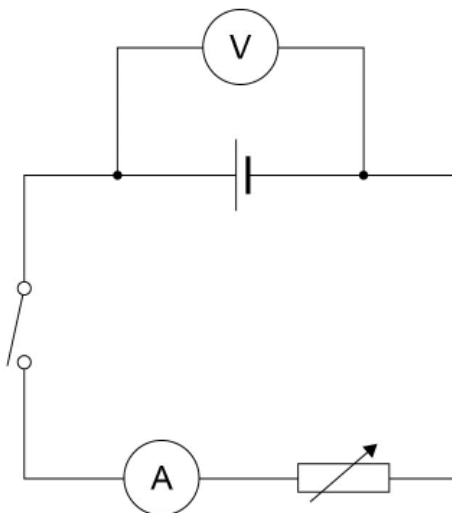

- With the switch open record the reading, V , on the voltmeter.
- Close the switch and take the readings of pd, V , on the voltmeter and current, I , on the ammeter.
- Adjust the variable resistor to obtain pairs of readings of V and I , over the widest possible range.
- Open the switch after each pair of readings. Only close it for sufficient time to take each pair of readings.
- Plot a graph of V on the y -axis against I .

Using $\epsilon = I(R+r)$ and $V = IR$

Gives $\epsilon = V + Ir$

Rearranging $V = \epsilon - Ir$

A graph of V against I will have a gradient = $-r$ and an intercept ϵ on the y -axis.

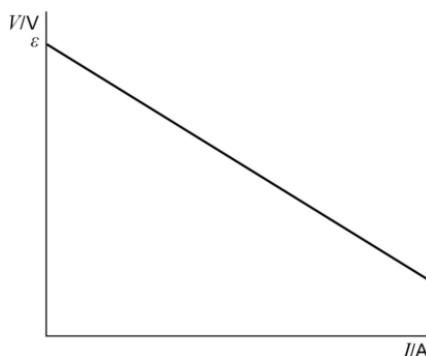

Practical 7

Required practical	Investigation into simple harmonic motion using a mass-spring system and a simple pendulum			
Apparatus and techniques covered (Relevant apparatus only, not full statements)	ATa. use appropriate analogue apparatus to record a range of measurements (to include length/distance) ATb. use appropriate digital instruments to obtain a range of measurements (to include time, mass) ATc. use methods to increase accuracy of measurements, such as timing over multiple oscillations and use of fiduciary marker ATd. use stopwatch for timing			
Indicative apparatus	Simple pendulum: Pendulum bob, string/thread, stopclock, pin & Blu-Tack (as fiduciary marker), retort stand, boss, clamp, small wooden blocks (to trap the string), metre ruler. Mass-spring system: Helical spring, slotted masses and hanger, (balance to check masses), stopclock, metre ruler, set square, pin and Blu-Tack, retort stand, boss, clamp.			
	Amount of choice Increasing independence 			
	Least choice	Some choice	Many choices	Full investigation
	Teacher gives students a full method with clear instructions as to how to set up the apparatus. All instruments and measurements are specified and students are instructed on the exact procedure and safety precautions.	Teacher allows students choice in method of timing oscillations. All procedural techniques are specified.	Teacher suggests outline investigation- to include relationship between time period and mass for a mass-spring system, and time period and length for a simple pendulum. Student decides on most appropriate measuring instruments and timing techniques to reduce uncertainty.	Teacher suggests general line of enquiry – to investigate factors affecting the time period of oscillations for a mass-spring system and simple pendulum. Student makes full decision about methodology, equipment and materials. All choices are fully justified with reference to experimental errors and safety.

Opportunities for observation and assessment of competencies				
Follow written procedures	✓✓✓ Students follow written method.	✓✓✓ Students follow written method.	✓✓✓ Students follow a method they have chosen.	✓✓✓ Students follow a method they have researched.
Applies investigative approaches and methods when using instruments and equipment	✓ Students correctly use the equipment and materials with minimum assistance and prompting.	✓✓ Students correctly use the equipment, carry out procedures methodically and make adjustments when necessary.	✓✓✓ Students select and correctly use the equipment, carry out procedures methodically and identify and control quantitative variables.	✓✓✓ Student must choose an appropriate approach, equipment and techniques, identify quantitative variables for measurement and control.
Safely uses a range of practical equipment and materials	✓ Students must safely use the equipment following advice given.	✓✓ Students must safely use the equipment with minimal prompting.	✓✓✓ Students minimise risks in all aspects of the investigation with no prompting.	✓✓✓ Students must carry out a full risk assessment and minimise risks.
Makes and records observations	✓✓ Students record observations as specified in the method, and record in a methodical way using appropriate units and conventions.	✓✓✓ Students obtain accurate, precise and sufficient data and records this methodically using appropriate units and conventions.	✓✓✓ Students obtain accurate, precise and sufficient data and records this methodically using appropriate units and conventions.	✓✓✓ Students obtain accurate, precise and sufficient data and records this methodically using appropriate units and conventions.
Researches, references and reports	✓ Students process data in prescribed way and compare results with expected relationships.	✓✓ Students process data in prescribed way and compare results with expected relationships identifying potential discrepancies and errors.	✓✓✓ Students identify appropriate methods/tools to process data and compare with expected relationships, identifying potential errors	✓✓✓ Students identify appropriate methods to process data, carry out research and report findings. Sources of information are cited together with supporting planning and conclusions.

✓✓✓: Very good opportunity ✓✓: Good opportunity ✓: Slight opportunity ✗: No opportunity

A-level Physics exemplar for required practical 7

Investigation into simple harmonic motion using a mass-spring system and a simple pendulum.

Teacher and technician sheet

This worksheet gives full details of the experiment, primarily for use by teachers and technicians who may be unfamiliar with the experiment. The worksheet would normally be adapted for student use to provide opportunity for students to make procedural decisions.

Simple pendulum to investigate how the time period varies with length and to measure g

Materials and equipment

- pendulum bob
- approximately 1.5 m string or thread
- two small wooden blocks to clamp the string
- stand, boss and clamp
- pin and Blu-Tack to use as fiducial mark
- metre ruler
- stopclock (reading to 0.01 s).

Technical information

This is a standard laboratory experiment which can be used to give an accurate value for the acceleration due to gravity. For accurate results it is important the pendulum oscillates with small amplitude and in a straight line.

Photographs of an exemplar set-up of this practical can be found in our set-up guide, which is available on our [A-level Practicals page](#).

Sample results

The table below shows sample readings for the pendulum and the mass-spring:

Pendulum	Spring
$L = 1.3 \text{ m}$	$m = 400 \text{ g}$
$T_{10} = 23.4 \text{ s}$	$T_{10} = 7.8 \text{ s}$
$g = 10.1 \text{ m s}^{-2}$	$k = 27.3 \text{ N m}^{-1}$

Student sheet

Method

- Attach the pendulum bob to the string and clamp it between two small wooden blocks.

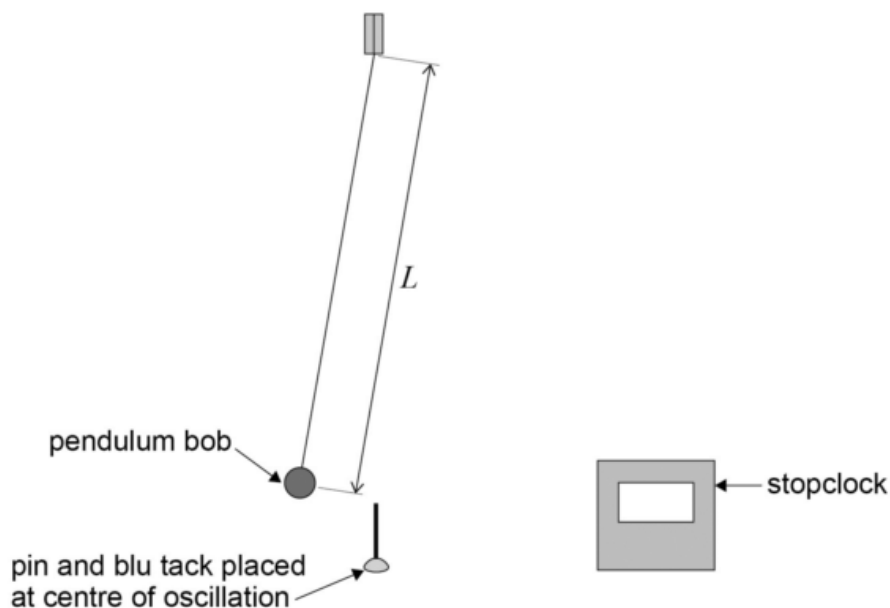

- Measure the length, L , of the pendulum from the point of suspension to the centre of mass of the pendulum bob. (It might be easier to measure to the top of the pendulum bob and then add on the radius of the bob to give L .)
- The pendulum should be suspended from the stand as shown, with a pin and Blu-Tack acting as a fiducial marker, placed immediately below the pendulum bob. This will be at the centre of the oscillation when the pendulum oscillates.
- Carefully pull the pendulum bob to the side and release it. The pendulum should oscillate with **small amplitude and in a straight line**. Check that it continues in a straight line by viewing the oscillation from the side – if not stop it and start the oscillation again.
- Determine the time period of the simple pendulum by timing 10 complete oscillations.
- Take repeat readings of the time for 10 oscillations, T_{10} .
- Change the length of the pendulum and repeat the process to determine the time period.
- Determine the time period of the pendulum for at least seven different lengths, L .
- Tabulate your data, including columns for L , T_{10} , repeat values of T_{10} , mean value of T_{10} , time period for one oscillation T , and an additional column for T^2 .
- Plot a graph of T^2 on the y -axis against L . A straight line through the origin verifies that T^2 is proportional to L .
- Measure the gradient of the graph and use it to determine a value for the acceleration due to gravity, g .
- Estimate the uncertainty in your values of L and T . Hence estimate the uncertainty in the value of g .

Simple pendulum

$$T = 2\pi \sqrt{\frac{l}{g}}$$

gives $T^2 = \frac{4\pi^2 L}{g}$ hence $g = \frac{4\pi^2}{\text{gradient}}$

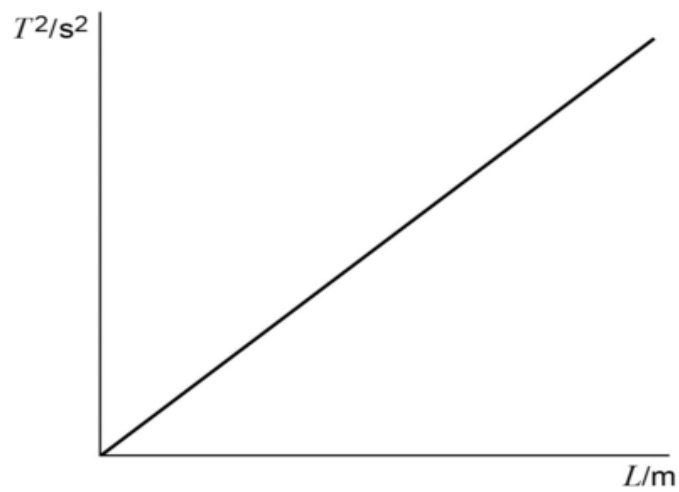

Mass-spring system

Teacher and technician sheet

Materials and equipment

- helical spring
- 100 g slotted mass hanger
- 100 g slotted masses
- stand, boss and clamp
- pin and Blu-Tack to use as fiducial mark
- metre ruler
- stopclock (reading to 0.01 s)

Technical information

Expendable springs (with k approximately 25 Nm^{-1}) are suitable for this experiment, together with a range of slotted masses from 0–800 g.

Photographs of an exemplar set-up of this practical can be found in our set-up guide, which is available on our [A-level Practicals page](#).

Sample results

The table below shows sample readings for the pendulum and the mass-spring.

Pendulum	Spring
$L = 1.3 \text{ m}$	$m = 400 \text{ g}$
$T_{10} = 23.4 \text{ s}$	$T_{10} = 7.8 \text{ s}$
$g = 10.1 \text{ m s}^{-2}$	$k = 27.3 \text{ N m}^{-1}$

Student sheet

Method

- Hang the spring from a clamp and attach the 100 g mass hanger. Ensure the spring is securely attached from its support.

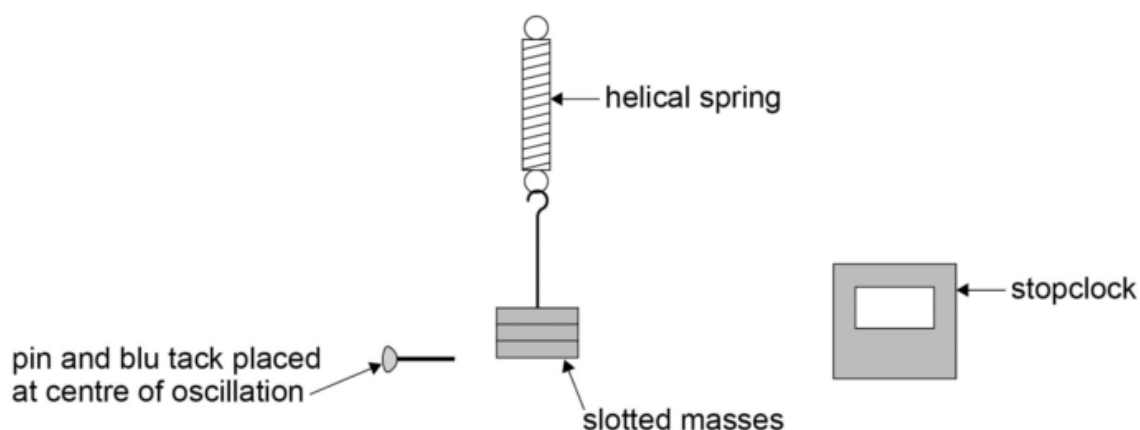

- Position the Blu-Tack and pin, acting as a fiducial marker, at the bottom of the mass as a reference point. This will represent the centre of the subsequent oscillations.
- Pull the mass hanger vertically downwards a few centimetres and release. The spring should oscillate vertically up and down.
- Determine the time period of the mass-spring system by timing 10 complete oscillations.
- Take repeat readings of the time for 10 oscillations, T_{10} . Use the values of T_{10} to find the time period for one oscillation, T .
- Add a 100 g mass to the mass hanger and repeat the timing process to enable the time period of the oscillations to be found.
- Repeat the experiment with a range of different masses, m , and for each mass determine the corresponding time period, T .
- Plot a graph of T^2 on the y -axis against m .

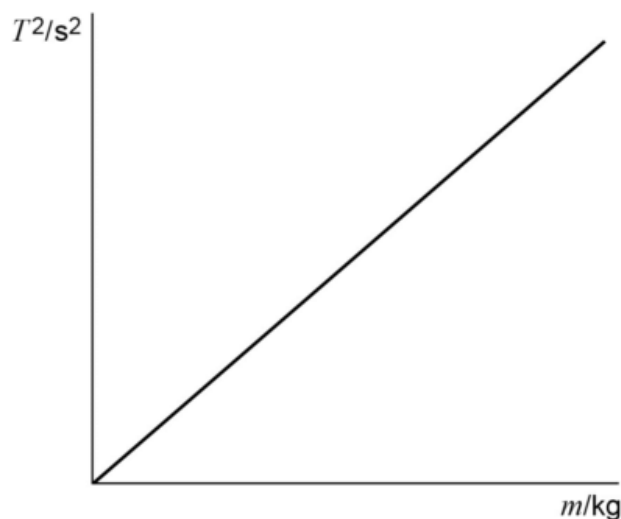

-
- A straight line through the origin will confirm the relationship between T and m predicted by SHM theory ie $T^2 = \frac{4\pi^2 m}{k}$ where k is the spring constant or stiffness of the spring.
 - The gradient of the graph can be used to determine k .

$$T^2 = \frac{4\pi^2 m}{k} \quad \text{hence} \quad k = \frac{4\pi^2}{\text{gradient}}$$

- Estimate the uncertainty in T and m . Hence find the uncertainty in k .

Practical 8

Required practical	Investigation of Boyle's (constant temperature) law and Charles's (constant pressure) law for a gas			
Apparatus and techniques covered (Relevant apparatus only, not full statements)	ATa. use appropriate analogue apparatus to record a range of measurements (to include length/distance, temperature, pressure)			
Indicative apparatus	<p>Boyle's law: 'Boyle's law apparatus' (wide bore glass tube, sealed at one end with air trapped by coloured oil. Scale mounted at the side of the tube and integral bourdon gauge), bicycle pump or foot pump.</p> <p>Charles's law: Capillary tube approximately 200 mm long, sealed at one end and containing air trapped by a small 'thread/length' of concentrated sulfuric acid. The capillary tube is attached to a mm scale. Thermometer, stirrer, beaker, method of heating water in the beaker (eg Bunsen burner, tripod and gauze).</p>			
	Amount of choice 			
	Increasing independence			
	Least choice	Some choice	Many choices	Full investigation
	Teacher gives students a full method with clear instructions as to how to set up the apparatus. All instruments and measurements are specified and students are instructed on the exact procedure and safety precautions.	Teacher allows students limited choice in identification and control of variables and range of readings. Otherwise all procedural techniques are specified.	Teacher indicates general method of investigating relationship between pressure and volume for a fixed mass of gas at constant temperature and between volume and temperature for a fixed mass of gas at constant pressure. Student decides on measurement techniques with guidance from teacher on suitable apparatus.	Teacher suggests general line of enquiry – to investigate the relationship between volume, pressure and temperature for a gas. Student decides on methodology and appropriate equipment and materials, with some guidance as to available apparatus. All choices are justified with reference to experimental errors and safety.

Opportunities for observation and assessment of competencies				
Follow written procedures	✓✓✓ Students follow written method.	✓✓✓ Students follow written method.	✓✓✓ Students follow a method they have chosen.	✓✓✓ Students follow a method they have researched.
Applies investigative approaches and methods when using instruments and equipment	✓ Students correctly use the equipment and materials with minimum assistance and prompting.	✓✓ Students correctly use the equipment, carry out procedures methodically and make adjustments when necessary.	✓✓ Students correctly use the equipment, carry out procedures methodically and identify and control quantitative variables.	✓✓✓ Student must choose an appropriate approach, equipment and techniques, identify quantitative variables for measurement and control.
Safely uses a range of practical equipment and materials	✓ Students must safely use the equipment following advice given.	✓✓ Students must safely use the equipment with minimal prompting.	✓✓✓ Students minimise risks in all aspects of the investigation with no prompting.	✓✓✓ Students must carry out a full risk assessment and minimise risks.
Makes and records observations	✓✓ Students record observations as specified in the method, and record in a methodical way using appropriate units and conventions.	✓✓✓ Students obtain accurate, precise and sufficient data and records this methodically using appropriate units and conventions.	✓✓✓ Students obtain accurate, precise and sufficient data and records this methodically using appropriate units and conventions.	✓✓✓ Students obtain accurate, precise and sufficient data and records this methodically using appropriate units and conventions.
Researches, references and reports	✓ Students process data in prescribed way and compare results with expected relationships.	✓✓ Students process data in prescribed way and compare results with expected relationships identifying potential discrepancies and errors.	✓✓✓ Students identify appropriate methods/tools to process data and compare with expected relationships, identifying potential errors and limitations.	✓✓✓ Students identify appropriate methods to process data, carry out research and report findings. Sources of information are cited together with supporting planning and conclusions.

✓✓✓: Very good opportunity ✓✓: Good opportunity ✓: Slight opportunity ✗: No opportunity

A-level Physics exemplar for required practical 8

Investigation of Boyle's (constant temperature) law and Charles's (constant pressure) law for a gas.

Teacher and technician sheet

This worksheet gives full details of the experiments, primarily for use by teachers and technicians who may be unfamiliar with the experiment. The worksheet would normally be adapted for student use to provide opportunity for students to make procedural decisions.

Boyle's law

Materials and equipment

- stand and clamp
- 10 cm³ syringe with 0.5 cm³ divisions
- 5 cm length of thin-walled rubber or silicone tubing to fit nozzle of syringe
- pinch clip
- 2 kg mass
- loop of string
- 9 × 100 g masses on a 100 g mass holder
- micrometer.

Technical information

- The syringe should be the type with a rubber seal on the plunger which is less likely to stick. The type with an O ring seal on the end of the plunger are better, and tend to stick less than the type where the end of the piston is made of solid rubber.
- The rubber tubing should fit tightly onto the nozzle of the syringe. It can then be folded over and clamped with the pinch clip to produce an airtight seal.
- The clip should be as close as possible to the nozzle. There will be a little air in the nozzle, but this has negligible volume compared to the volume of air in the barrel of the syringe.
- A loop of string should be tied to the end of the plunger so that the mass holder can be hung on it.
- The 2 kg mass is used as a counterweight to ensure the stand does not topple over (an alternative would be to clamp the stand to the bench using a G-clamp).

Photographs of an exemplar set-up of this practical can be found in our set-up guide, which is available on our [A-level Practicals page](#).

Sample results

The table below shows sample readings for a 20 cm³ syringe:

$d = 20 \text{ mm}$		
m / kg	V / cm^3	P / kPa
0.4	4.0	88.5
0.9	5.0	72.9
1.3	6.0	60.4
1.6	7.0	51.0

Student sheet

Method

- Remove the plunger from the syringe and measure the diameter of the rubber seal, d , using the micrometer. Convert this into metres.
- Calculate the cross-sectional area of the seal $A = \pi d^2/4$ in m^2 .
- Replace the plunger and draw in 4.0 cm^3 of air.
- Fit the rubber tubing over the nozzle, fold the tubing over and clamp it with the pinch clip as close to the nozzle as possible.

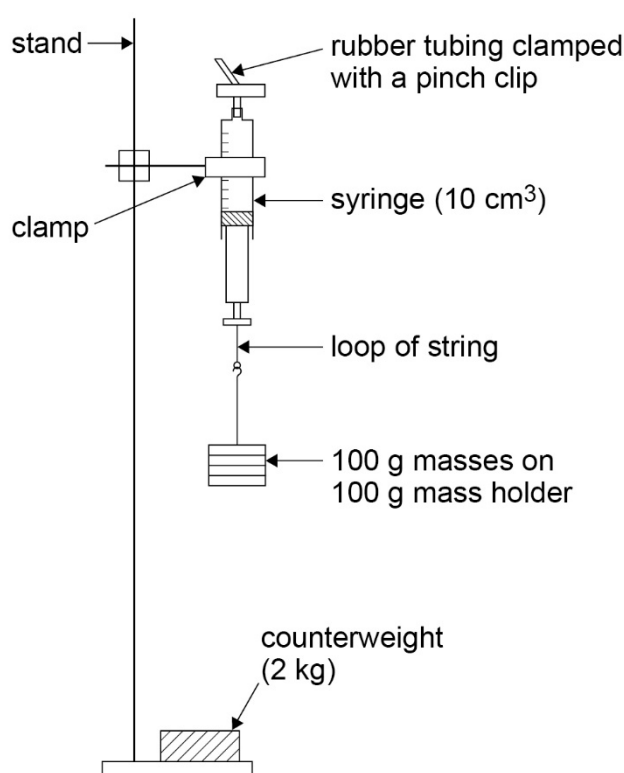

- Set up the apparatus as shown in the diagram initially with the 100 g mass holder carrying one 100 g mass. Ensure that the string is securely attached to the plunger handle. The clamp should be above the plunger so that the scale can be read. Clamping the syringe barrel can distort it, making it more difficult for the plunger to move freely. Consequently ensure the clamp is high enough on the barrel above the position where the plunger moves. There should be sufficient room below the masses so that the plunger can move down as masses are added.
- Gently move the plunger up and down a few millimetres to ensure it is not sticking.
- Read the new volume on the syringe scale (fractions of a division should be estimated).
- Repeat the procedure with an extra two 100 g masses added to the holder each time, up to a total mass of 1000 g.
- The whole experiment should then be repeated to obtain a second set of results, and the mean volumes found.

-
- The force exerted by the masses can be calculated using $F = mg$ where m is the mass in kg and g , the gravitational field strength, is 9.81 Nkg^{-1} .
 - The pressure exerted by this force on the air sample is then F/A in Pascals (Pa). Convert this into kPa.
 - This should be subtracted from standard atmospheric pressure, 101 kPa, to obtain the pressure of the air sample, P . (Note: the initial volume of the air with no masses hung on the loop will be at standard atmospheric pressure).
 - A graph of $1/V$ against P should then be plotted (where V is the mean volume of the air sample for each value of P).
 - Provided care has been taken to ensure the plunger does not stick, a reasonable straight line through the origin should be obtained. (Any slight sticking could result in a graph which curves slightly and/or does not pass through the origin).

Charles's law

Teacher and technician sheet

Materials and equipment

- 25 cm length of glass capillary tubing (eg outer diameter 5 mm and bore 1 mm – whilst other sizes will work the bore should not exceed 1 mm)
- 5 cm length of thin-walled rubber tubing to fit over the end of the capillary tubing
- contact adhesive
- concentrated sulfuric acid
- 30 cm ruler
- 2 elastic bands
- thermometer (eg -10 to 110 °C)
- 2 litre beaker
- 250 cm³ glass beaker
- paper towels
- kettle.

Technical information

As concentrated sulfuric acid is being used, safety spectacles or goggles must be worn. Lab coats and gloves could also be worn. The technician should prepare the capillary tubing with a small drop of concentrated sulfuric acid about half way down its length, with the lower end sealed using contact adhesive. This can be achieved as shown below.

- Pour a little concentrated sulfuric acid into a 250 cm³ glass beaker.
- Attach the length of rubber tubing to one end of the capillary tubing.
- Place the other end into the acid.
- Pinch the rubber tubing, then place a finger over the end and release the tubing to draw a drop of acid into the capillary tube.
- Remove the capillary tube from the acid, and use the same pinch and release technique to move the drop of acid to about half way along the tube.
- Holding the capillary tube horizontally, remove the rubber tubing from the end, and apply a small amount of adhesive to this end of the capillary tubing (see diagram on the following page).
- Using a paper towel, wipe off any surplus acid from the other end of the capillary tubing.
- Leave the tube for the contact adhesive to dry.
- Attach the capillary tubing to a 30 cm ruler using the elastic bands, with the end sealed with contact adhesive at the zero mark.
- The drop of concentrated sulfuric acid will dry the air as well as trap the sample of air in the capillary tubing.

The method suggests adding hot water to the beaker and allowing it to cool to produce the required variation in temperature. This is safer than heating a large beaker of water using a

Bunsen and tripod. If a plastic 30 cm ruler is used, the boiled water should be allowed to cool a little before pouring it into the beaker in order to avoid the plastic softening. Students must be told that the apparatus contains concentrated sulfuric acid, and to treat it with care. If dropped or broken, it should be reported immediately and cleared up by someone wearing safety goggles.

Sealing the capillary tubing

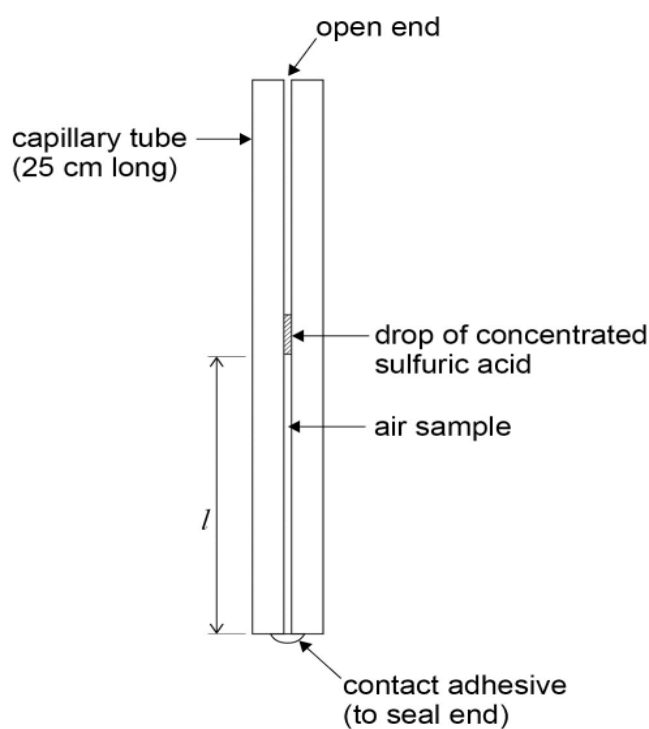

Additional notes

Capillary tubing with a 1 mm diameter bore as a maximum is recommended.

The bore of the tube needs to be 'clinically clean' ie no slight traces of oil, grease or other chemicals. This is often the reason why the thread of concentrated sulfuric acid splits.

There is a limit to how long they can be stored for. Some teachers have fed back that they have used them in successive years, but most tend to set new tubes up for each new year group.

Photographs of an exemplar set-up of this practical can be found in our set-up guide, which is available on our [A-level Practicals page](#).

Sample results

The table below shows sample readings for a 1 mm bore capillary tube:

$\theta / ^\circ\text{C}$	l / cm
92.0	26.7
77.0	26.1
65.0	25.6
51.0	25.3
38.0	24.9
23.0	24.5

Student sheet

Method

- Set up the apparatus as shown in the diagram with the open end of the capillary tube at the top. Allow the boiled water from the kettle to cool a little before pouring it into the beaker. The hot water should cover the air sample.

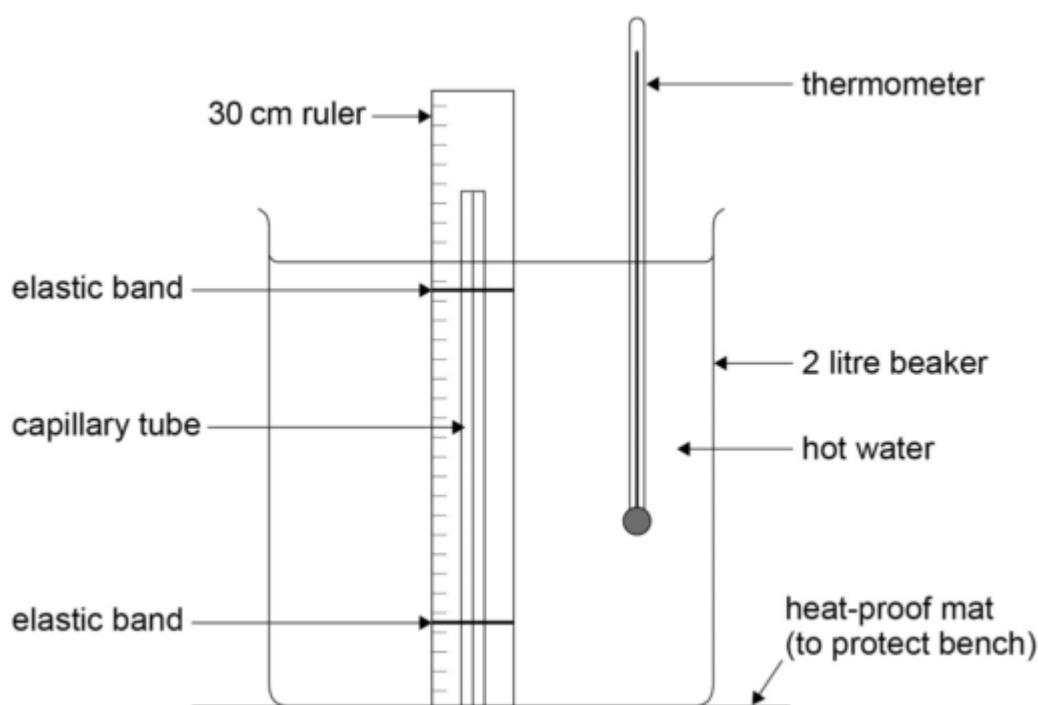

- Stir the water well using the thermometer, read the value of its temperature, θ , and the length of the air sample, l , on the 30 cm ruler (see diagram above).
- Allow the water to cool by 5°C and repeat the procedure until room temperature has been reached. (The cooling process can be speeded up by pouring a little water out of the beaker and topping it up with cold water.)
- Plot a graph of l against θ . Start the axes at a convenient value, and use a scale which will give a spread of points over at least half the graph paper in both directions.
- Draw the best straight line of fit through the points and find the gradient, m .
- The form of the graph is $l = m\theta + c$, where c is the value of l when $\theta = 0^\circ\text{C}$.
- The value of c can be found by reading a pair of values for length and temperature for a point on the straight line (l_1 and θ_1 , say). Then $c = l_1 - m\theta_1$.
- An estimate of the value of absolute zero, θ_0 , can then be found by substituting $l = 0$ into the equation for the form of the graph: $0 = m\theta_0 + c$ so $\theta_0 = -c/m$.

Practical 9

Required practical		Investigation of the charge and discharge of capacitors			
Apparatus and techniques covered (Relevant apparatus only, not full statements)	ATb. use appropriate digital instruments, including electrical multimeters, to obtain a range of measurements (to include time, voltage) ATd. use stopwatch for timing ATf. correctly construct circuits from circuit diagrams using DC power supplies, cells, and a range of circuit components, including those where polarity is important ATg. design, construct and check circuits using DC power supplies, cells, and a range of circuit components				
	Indicative apparatus DC power supply or cells, selection of electrolytic capacitors, selection of fixed resistors, digital voltmeter or multimeter, stopclock, connecting leads.				
		Amount of choice			
		Increasing independence			
		Least choice	Some choice	Many choices	Full investigation
		Teacher gives students a full method with clear instructions/circuit diagram as to how to set up the circuit. All instruments including ranges, are given and all details of the experiment are fully specified.	Student has limited choice in instruments and range of readings - eg voltage readings and time intervals. Resistor and Capacitor values are suggested, and all other aspects of the investigation are fully specified.	Teacher suggests outline method to investigate charging and discharging of capacitors. Students decide on control of variables instruments, ranges and component values after preliminary experiments.	Teacher poses problem - to investigate how the time taken in charging and discharging a capacitor through a resistor is related to capacitance and resistance. Student makes full decision about methodology, equipment and materials. All choices are fully justified with reference to experimental errors and safety.
Opportunities for observation and assessment of competencies					
Follow written procedures	✓✓✓ Students follow written method.	✓✓✓ Students follow written method.	✓✓✓ Students follow a method they have chosen.	✓✓✓ Students follow a method they have researched.	

Applies investigative approaches and methods when using instruments and equipment	✓ Students correctly use the equipment and materials with minimum assistance and prompting.	✓✓ Students correctly use the equipment, carry out procedures methodically and make adjustments when necessary.	✓✓ Students select and correctly use the equipment, carry out procedures methodically and identify and control quantitative variables.	✓✓✓ Student must choose an appropriate approach, equipment and techniques, identify quantitative variables for measurement and control.
Safely uses a range of practical equipment and materials	✓ Students must safely use the equipment following advice given.	✓✓ Students must safely use the equipment with minimal prompting.	✓✓✓ Students minimise risks in all aspects of the experiment with no prompting.	✓✓✓ Students must carry out a full risk assessment and minimise risks.
Makes and records observations	✓✓ Students record observations as specified in the method, and record in a methodical way using appropriate units and conventions.	✓✓✓ Students obtain accurate, precise and sufficient data and records this methodically using appropriate units and conventions.	✓✓✓ Students obtain accurate, precise and sufficient data and records this methodically using appropriate units and conventions.	✓✓✓ Students obtain accurate, precise and sufficient data and records this methodically using appropriate units and conventions.
Researches, references and reports	✓ Students process data in prescribed way and compare results with expected values.	✓✓ Students process data in prescribed way and compare results with expected values identifying potential discrepancies and errors.	✓✓✓ Students identify appropriate methods/tools to process data and compare with expected values, identifying potential discrepancies and errors.	✓✓✓ Students identify appropriate methods to process data, carry out research and report findings. Sources of information are cited together with supporting planning and conclusions.

✓✓✓: Very good opportunity ✓✓: Good opportunity ✓: Slight opportunity ✗: No opportunity

A-level Physics exemplar for required practical 9

Investigation of the charge and discharge of capacitors.

Teacher and technician sheet

This worksheet gives full details of the experiment, primarily for use by teachers and technicians who may be unfamiliar with the experiment. The worksheet would normally be adapted for student use to provide opportunity for students to make procedural decisions.

Materials and equipment

- stopclock
- electrolytic capacitors (suitable values: 1000 μF , 2200 μF , 4700 μF)
- resistors (0.25 W carbon film, values in the range 10 k Ω to 100 k Ω)
- battery 3 V, 6 V or 9 V
- digital voltmeter, range 0–10 V
- SPDT (single pole double throw) switch
- connecting leads.

Technical information

- It is essential that the electrolytic capacitors are connected into the circuit with **correct polarity**, as indicated on the capacitor body. The voltage rating of the capacitor should also be greater than the dc supply used.
- Resistor and capacitor values, indicated above, have been chosen to give a time constant RC in the range 10 s to 500 s.

Photographs of an exemplar set-up of this practical can be found in our set-up guide, which is available on our [A-level Practicals page](#).

Sample results

The table below shows sample readings for a 2200 μF capacitor and a 22 k Ω resistor:

Discharge	
t / s	V / V
0.00	9.30
10.00	7.61
20.00	6.13
30.00	4.90
40.00	4.12
60.00	2.98

Charge	
t / s	V / V
3.00	1.00
10.00	3.00
20.00	5.00
58.00	6.00
120.00	6.50

Discharging a capacitor through a resistor

Student sheet

Method

- Set up the circuit as shown in the diagram (taking care to ensure the polarity of the capacitor is correct).

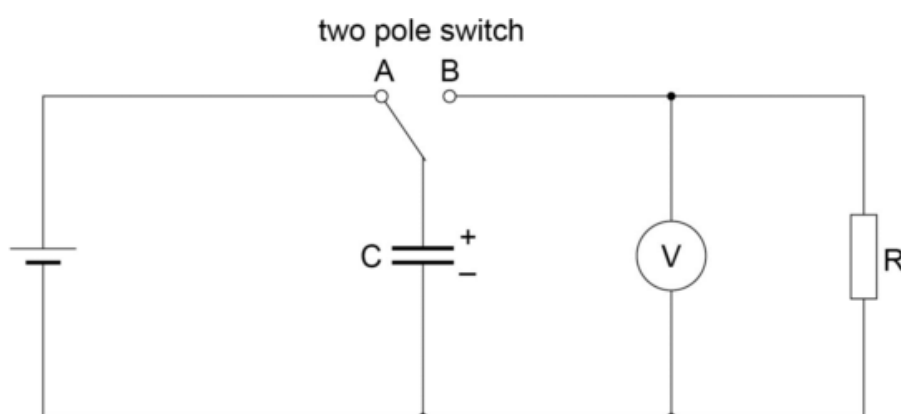

- With the two pole switch in position A the capacitor will charge. The internal resistance of the battery is usually enough to limit the charging current to a safe value, but allowing the capacitor to charge up almost instantly.
- The switch should now be moved to position B so that the capacitor, C , will discharge through the resistor, R . (It is well worth doing a 'trial discharge' at this point, to see how quick the discharge is so that a suitable time interval can be decided when taking voltage readings during the discharge process).
- After the 'trial discharge' move the switch to position A to charge up the capacitor.
- Switch to position B, start the stopclock, and observe and record the voltage reading at time $t = 0$. Continue to take voltage readings at 5 s intervals as the capacitor discharges. (For a slower discharge, voltage readings at 10 s intervals will be sufficient).
- Repeat the process with the same capacitor and different resistors.
- The process can also be repeated with different capacitors.
- Plot a graph of pd across the capacitor, V , on the y -axis against time, t . This should give an exponential decay curve, as given by the equation $V = V_0 e^{-t/RC}$
- To confirm that this is an exponential, plot a graph of $\ln(V/V_0)$ on the y -axis against t .

This will give a straight line graph with a negative gradient according to the 'log form' of the equation

$$\ln(V) = \ln(V_0) - t/RC$$

This graph will have a gradient of $-\frac{1}{RC}$

Hence, the time constant RC can be determined from the gradient of the graph. If R is known, the value of C can also be found.

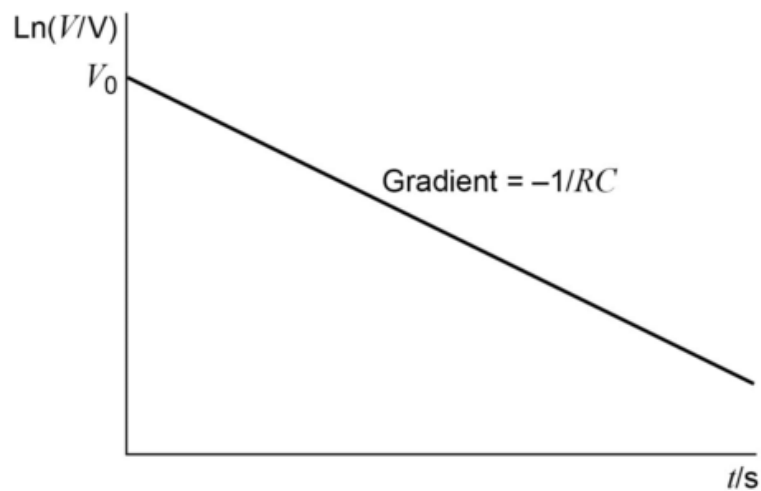

Charging a capacitor through a resistor

Teacher and technician sheet

Materials and equipment

- stopclock
- electrolytic capacitors (suitable values: 1000 μF , 2200 μF , 4700 μF)
- resistors (0.25 W carbon film, values in the range 10 k Ω to 100 k Ω)
- battery 3 V, 6 V or 9 V
- digital voltmeter, range 0–10 V
- SPST (single pole single throw) switch
- connecting leads.

Charging a capacitor through a resistor

Student sheet

Method

- Set up the circuit as shown in the diagram. (Ensure the capacitor is connected with correct polarity). With the switch open and the capacitor initially uncharged, the voltmeter should read zero.

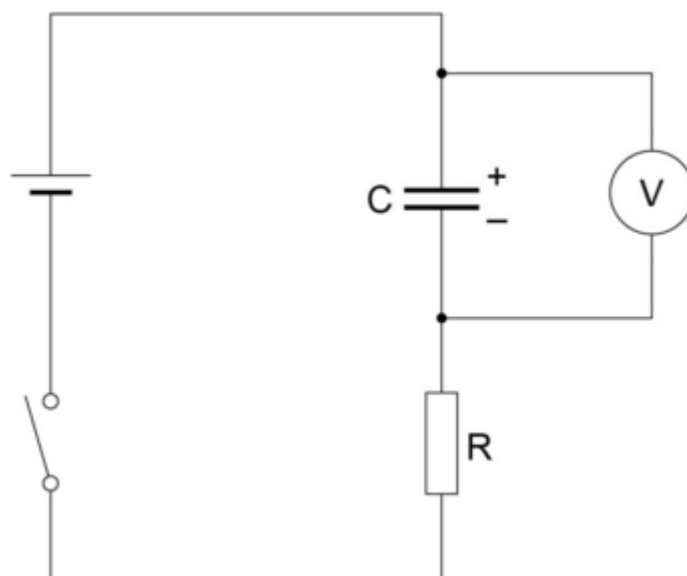

- Close the switch to start the charging process and observe and record the voltage across the capacitor at 5 s intervals (or longer time intervals if the charging process is 'slow').
- Repeat with different combinations of C and R. Ensure the capacitor is completely discharged before starting each new charging process
- Plot graphs of pd, V , on the y -axis against time, t . The graph will show an 'exponential growth' of pd across the capacitor as it charges as given by the equation.

$$V = V_0(1 - e^{-t/RC})$$

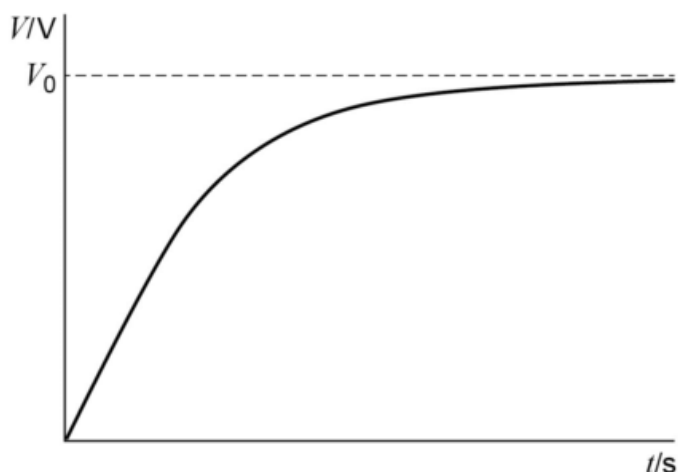

Practical 10

Required practical	Investigation of the relationship between the force, magnetic flux density, current and length of wire using a top pan balance			
Apparatus and techniques covered (Relevant apparatus only, not full statements)	ATa. use appropriate analogue apparatus to record a range of measurements (to include length/distance) ATb. use appropriate digital instruments to obtain a range of measurements (to include current, mass) ATf. correctly construct circuits from circuit diagrams using DC power supplies, cells, and a range of components			
Indicative apparatus	Top pan electronic balance, U-shaped mild steel yoke, 4 or 6 magnadur 'slab' magnets (to fit in yoke), dc power supply or battery, rheostat, ammeter, range of different length U-shaped copper wires (to place different lengths of wire in the magnetic field), connecting leads, length of wood or ruler (to attach-shaped wires), retort stand, boss and clamps.			
	Amount of choice			
	Increasing independence			
	Least choice	Some choice	Many choices	Full investigation
	Teacher gives students a full method with clear instructions as to how to set up the apparatus. All instruments and measurements are specified and students are instructed on the exact procedure and safety precautions.	Teacher specifies each aspect of the investigation but gives student some element of choice in devising a suitable circuit to produce a variable current. Otherwise all procedural techniques are specified.	Teacher indicates general method for the experiment but student decides on range of readings, control of variables and measurement techniques following a preliminary experiment.	After an introductory piece of work where student has had experience of the 'motor' effect and associated techniques, teacher sets task: to investigate how the force on a current carrying conductor in a magnetic field varies with current, magnetic flux density and length of wire. Student decides on methodology and appropriate equipment and materials. All choices are justified with reference to experimental errors and safety.

Opportunities for observation and assessment of competencies				
Follow written procedures	✓✓✓ Students follow written method.	✓✓✓ Students follow written method.	✓✓✓ Students follow a method they have chosen.	✓✓✓ Students follow a method they have researched.
Applies investigative approaches and methods when using instruments and equipment	✓ Students correctly use the equipment and materials with minimum assistance and prompting.	✓✓ Students correctly use the equipment, carry out procedures methodically and make adjustments when necessary.	✓✓ Students correctly use the equipment, carry out procedures methodically and identify and control quantitative variables.	✓✓✓ Student must choose an appropriate approach, equipment and techniques, identify quantitative variables for measurement and control.
Safely uses a range of practical equipment and materials	✓ Students must safely use the equipment following advice given.	✓✓ Students must safely use the equipment with minimal prompting.	✓✓✓ Students minimise risks in all aspects of the investigation with no prompting.	✓✓✓ Students must carry out a full risk assessment and minimise risks.
Makes and records observations	✓✓ Students record observations as specified in the method, and record in a methodical way using appropriate units and conventions.	✓✓✓ Students obtain accurate, precise and sufficient data and records this methodically using appropriate units and conventions.	✓✓✓ Students obtain accurate, precise and sufficient data and records this methodically using appropriate units and conventions.	✓✓✓ Students obtain accurate, precise and sufficient data and records this methodically using appropriate units and conventions.
Researches, references and reports	✓ Students process data in prescribed way and compare results with expected relationships.	✓✓ Students process data in prescribed way and compare results with expected relationships identifying potential discrepancies and errors.	✓✓✓ Students identify appropriate methods/tools to process data and compare with expected relationships, identifying potential errors and limitations.	✓✓✓ Students identify appropriate methods to process data, carry out research and report findings. Sources of information are cited together with supporting planning and conclusions.

✓✓✓: Very good opportunity ✓✓: Good opportunity ✓: Slight opportunity ✗: No opportunity

A-level Physics exemplar for required practical 10

Investigation of the relationship between magnetic flux density, current and length of wire using a top pan balance.

Teacher and technician sheet

This worksheet gives full details of the experiment, primarily for use by teachers and technicians who may be unfamiliar with the experiment. The worksheet would normally be adapted for student use to provide opportunity for students to make procedural decisions.

Materials and equipment

- a 25 cm length of straight bare copper wire of thickness 1.5 mm, for example
- low voltage variable DC supply (eg 0–6 V)
- ammeter (eg 0–10 A with 0.1 A precision or better)
- two crocodile clips
- two clamps on stands
- three connecting leads
- four magnadur magnets with a metal cradle
- an electronic top pan balance with precision 0.1 g or better
- 30 cm ruler.

Technical information

- High currents (up to 6 A) will flow through the wire, so care must be taken as it will get warm.
- The current and field directions shown in the diagrams will give an upward force on the wire according to Fleming's left hand rule. However, because the wire is clamped and cannot move, there will be a downward force acting on the magnets and cradle which will cause the reading on the electronic balance to increase.
- Add a rheostat (11 Ω works fine) in series to vary the current.
- Rotate the magnadur magnets by 90° to obtain more data with different wire length, L .

Photographs of an exemplar set-up of this practical can be found in our set-up guide, which is available on our [A-level Practicals page](#).

Sample results

The table below shows sample readings using a top pan balance with 0.01 g precision:

$L = 50.9 \text{ mm}$	
I / A	m / g
0.63	0.17
0.97	0.25
1.45	0.38
2.24	0.55
3.42	0.83
5.48	1.31

Student sheet

Method

- Set up the apparatus as shown in the diagrams (3 views of the apparatus have been given to make the arrangement clear).

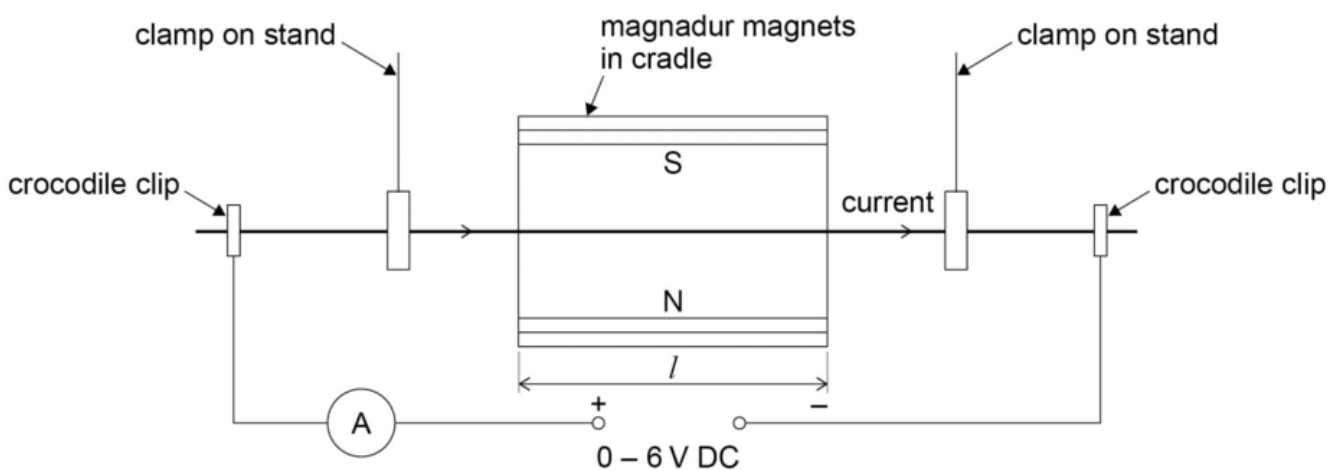
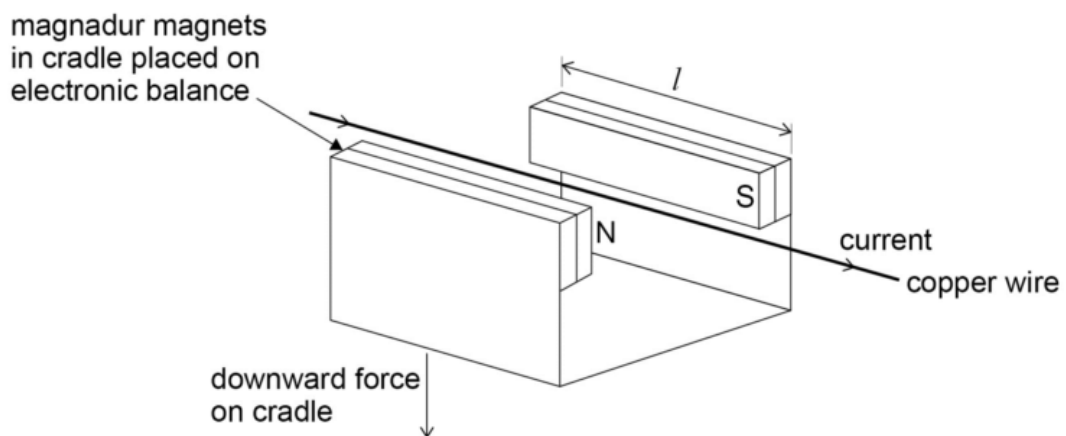
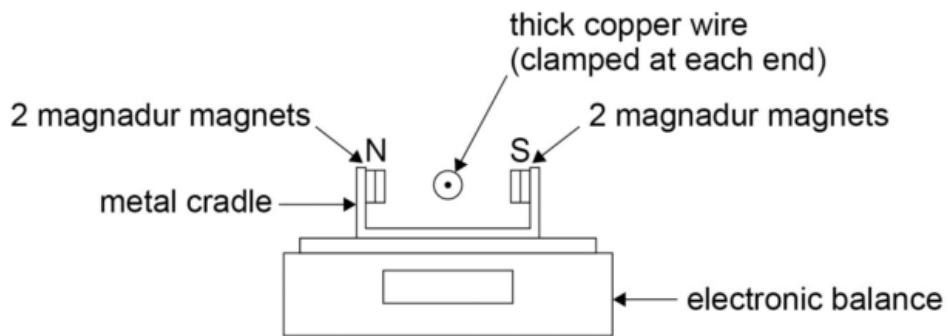

- With no current flowing through the wire, the electronic balance should be set to zero.
- Adjust the voltage of the supply so that the current, I , flowing through the wire is 6.0 A as measured on the ammeter.
- Read the top pan balance display, m , in grams.
- Repeat the procedure for $I = 5.0, 4.0, 3.0, 2.0$ and 1.0 A.
- Obtain a second set of results by repeating the experiment and find the mean value of m for each value of I .
- Plot a graph of the mean m against I .
- Draw the best straight line of fit through the points and find the gradient (the graph should be a straight line through the origin).
- Measure the length of the magnet wire, L , in metres. (This will be the length of wire in the magnetic field, ignoring edge effects).

The force on the wire is:

$F = BIL$ (where B is the magnetic flux density in Tesla)

$F = mg/1000$ (converting m into kg and with $g = 9.81 \text{ Nkg}^{-1}$)

Equating

$$BIL = mg/1000$$

Re-arranging

$$B = mg/(I \times L \times 1000)$$

The gradient of the graph gives m/I

Hence $B = \text{gradient} \times g/(L \times 1000)$

The value obtained for B is typically around $5 \times 10^{-2} \text{ Tesla}$

Practical 11

Required practical	Investigate the effect on magnetic flux linkage by varying the angle using a search coil and oscilloscope			
Apparatus and techniques covered (Relevant apparatus only, not full statements)	ATa. use appropriate analogue apparatus to record a range of measurements (to include angles) ATb. use appropriate digital instruments ATf. correctly construct circuits from circuit diagrams using dc power supplies, cells, and a range of circuit components ATh. use of oscilloscope, including volts/division			
Indicative apparatus	Circular coil 15–20 cm diameter, stand or ‘holder’ for circular coil, axial or lateral search coil (to position in the centre of the circular coil), protractor, retort stand, boss and clamp (for search coil), oscilloscope, low voltage 50 Hz AC supply or AF signal generator, connecting leads.			
	Amount of choice			
	Increasing independence			
	Least choice	Some choice	Many choices	Full investigation
	Teacher gives students a full method with circuit diagram and clear instructions as to how to set up the apparatus. All instruments and measurements are specified and students are instructed on the exact procedure and safety precautions.	Teacher allows students to decide how to use the oscilloscope to measure the induced emf from the search coil, including selection of the most appropriate voltage sensitivity setting and time base. Otherwise all other procedural techniques are specified.	Teacher suggests outline investigation - using a search coil to investigate the effect on magnetic flux linkage of varying the angle. Student conducts preliminary experiment to decide on range of readings and refinement of techniques to vary the angle of the coil in the magnetic field and how to produce and measure the induced emf.	Teacher suggests general line of enquiry at the end of a piece of work where the student has had experience in the measurement of magnetic flux density. Student makes full decision about methodology, equipment and materials. All choices are fully justified with reference to experimental errors and safety.
Opportunities for observation and assessment of competencies				
Follow written procedures	✓✓✓ Students follow written method.	✓✓✓ Students follow written method.	✓✓✓ Students follow a method they have chosen.	✓✓✓ Students follow a method they have researched.

Applies investigative approaches and methods when using instruments and equipment	✓ Students correctly use the equipment and materials with minimum assistance and prompting.	✓✓ Students correctly use the equipment, carry out procedures methodically and make adjustments when necessary.	✓✓✓ Students select and correctly use the equipment, carry out procedures methodically and identify and control quantitative variables.	✓✓✓ Student must choose an appropriate approach, equipment and techniques, identify quantitative variables for measurement and control.
Safely uses a range of practical equipment and materials	✓ Students must safely use the equipment following advice given.	✓✓ Students must safely use the equipment with minimal prompting.	✓✓✓ Students minimise risks in all aspects of the investigation with no prompting.	✓✓✓ Students must carry out a full risk assessment and minimise risks.
Makes and records observations	✓✓ Students record observations as specified in the method, and record in a methodical way using appropriate units and conventions.	✓✓✓ Students obtain accurate, precise and sufficient data and records this methodically using appropriate units and conventions.	✓✓✓ Students obtain accurate, precise and sufficient data and records this methodically using appropriate units and conventions.	✓✓✓ Students obtain accurate, precise and sufficient data and records this methodically using appropriate units and conventions.
Researches, references and reports	✓ Students process data in prescribed way and compare results with expected relationships.	✓✓ Students process data in prescribed way and compare results with expected relationships identifying potential discrepancies and errors.	✓✓ Students identify appropriate methods/tools to process data and compare with expected relationships, identifying potential discrepancies and errors.	✓✓✓ Students identify appropriate methods to process data, carry out research and report findings. Sources of information are cited together with supporting planning and conclusions.

✓✓✓: Very good opportunity ✓✓: Good opportunity ✓: Slight opportunity ✗: No opportunity

A-level Physics exemplar for required practical 11

Investigation of the effect on magnetic flux linkage of varying the angle using a search coil and oscilloscope.

Teacher and technician sheet

This worksheet gives full details of the experiment, primarily for use by teachers and technicians who may be unfamiliar with the experiment. The worksheet would normally be adapted for student use to provide opportunity for students to make procedural decisions.

Materials and equipment

- oscilloscope
- large circular coil
- stand (or support) for circular coil
- low voltage 50 Hz AC supply (or AF signal generator)
- connecting leads
- protractor
- axial or lateral search coil
- stand, boss and clamp to support search coil.

Technical information

- The exact set up for this experiment will depend on the circular coils and search coils available in your laboratory. A large circular coil of approximately 15–20 cm diameter is connected to an AC supply. The search coil can be positioned to investigate the magnetic field at the centre of the circular coil.
- An oscilloscope connected to the search coil can be used to measure the induced emf, which is proportional to the magnetic field strength and flux linkage in the search coil. By tilting the search coil at different angles to the field, the variation of flux linkage with angle can be investigated.
- The circular coil can be placed flat (horizontal) on a suitable surface or mounted vertically with a stand. If you have a pair of circular coils used as Helmholtz coils, one of these could be used together with the dedicated stand which supports the coils vertically. Do not exceed the specified current rating for the coil or damage will result.
- Alternatively a circular coil can be made by wrapping about 10 turns of 0.45 mm PVC covered copper wire into a coil of about 15 cm diameter. This can be placed flat on the bench. A 50 Hz AC current of about 5 A will usually provide a sufficiently strong field at the centre of this coil. (This is similar to the arrangement suggested in the Nuffield Advanced physics course.)
- Either an axially or laterally mounted search coil can be used. The search coil can be clamped at the centre of the large circular coil. The induced emf in the search coil can be measured on the oscilloscope.
- If the induced voltage is not large enough to measure on the oscilloscope, an AF signal generator can be used with the circular coil instead of the 50 Hz AC supply. The higher frequency will give a greater induced emf in the search coil. (Typically a frequency of 5–10 kHz might be used, but some preliminary experimentation is required to find what works best with your circular coil and search coil).

- Use a 'protractor card' under a circular coil to measure the angle between coil and search coil (see image below)

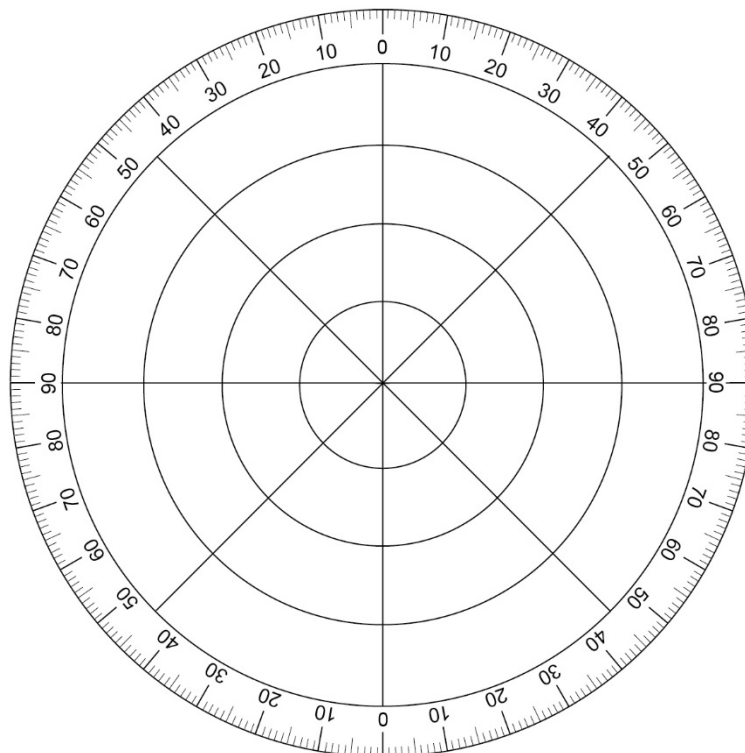

- Use blu tack and optical pins to point the centre of the circular coil for consistent readings when rotating the search coil.
- For better precision reading of the angle, use 3D printed arrangement.

Side view of circular coil, showing side view of axial search coil in centre (clamps and stands not shown).

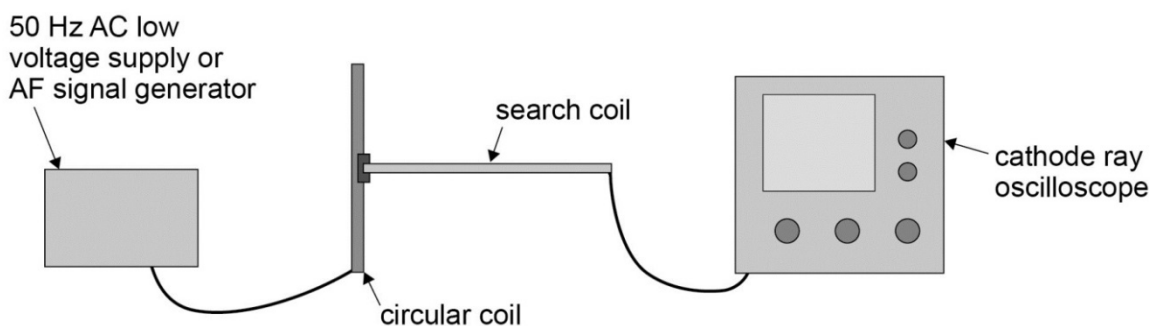

Photographs of an exemplar set-up of this practical can be found in our set-up guide, which is available on our [A-level Practicals page](#).

Sample results

The table below shows sample readings using a search coil and CRO:

$\cos \theta$	V_{pp} / mV
0.174	24
0.342	48
0.500	72
0.643	88
0.766	104
0.866	120
0.940	128
0.985	132
1.000	134

Alternative method using a Hall probe

The variation of magnetic flux linkage with angle can easily be investigated with a hall probe. This has the advantage that the magnetic field around a permanent magnet can be investigated.

In the above experiment with the circular coil, the search coil and oscilloscope can be replaced by a hall probe and voltmeter. The hall voltage is proportional to the magnetic field strength. There is no requirement for a varying field to produce an induced emf, so a low voltage DC supply is connected to the circular coil instead of the AC supply. The probe can be placed at various angles in the 'steady' field at the centre of the circular coil, and the corresponding hall voltage measured.

The hall probe could also be used to investigate the variation in flux linkage with angle, using the magnetic field from a permanent magnet, as shown below. The hall probe can be rotated at varying angles in the field, and the corresponding hall voltage recorded.

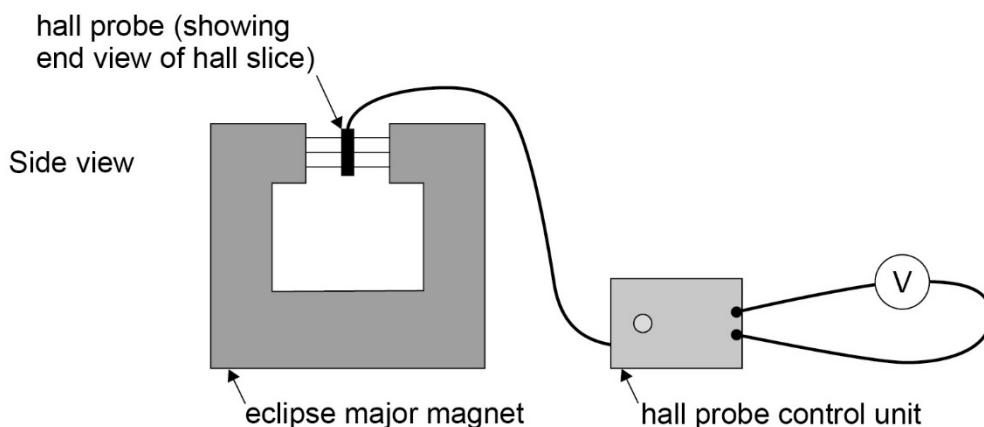

Student sheet

Method

- The search coil is clamped so that the plane of the coil is initially parallel to the plane of the large circular coil, and therefore perpendicular to the B-field lines produced by the circular coil, as shown in the diagram. This position will produce maximum flux linkage and maximum induced emf in the search coil.
- A preliminary experiment will be necessary to determine the appropriate voltage (and frequency) to use on the circular coil. (An ammeter might be required to ensure the current through the circular coil does not exceed the manufacturer's specifications.) Select suitable voltage sensitivity and time base settings on the oscilloscope, to establish that the induced emf produced in the search coil is large enough to be easily measured.
- With the search coil in the initial position, as shown, record the induced emf in the search coil from the CRO display – eg by measuring peak to peak value of the induced AC voltage.
- Tilt the angle of the search coil and use a protractor to measure the angle between the plane of the circular coil and the plane of the search coil. (It might be possible to clamp a large protractor behind the search coil support rod, although students could be set the task of devising a suitable method to measure this angle). Measure the corresponding induced emf in the search coil from the CRO display.
- Repeat for a range of angles from 0° to 90° between the search coil and the circular coil, and in each case measure the corresponding induced emf in the search coil.
- Plot a graph to show the variation of induced emf against the angle of the search coil in the field. This should be maximum for the position shown in the diagram, where the angle between the plane of the circular coil and the plane of the search coil is 0° . The induced emf should be zero when the plane of the search coil is at an angle of 90° to the plane of the circular coil.

Practical 12

Required practical		Investigation of the inverse-square law for gamma rays			
Apparatus and techniques covered (Relevant apparatus only, not full statements)	ATa. use appropriate analogue apparatus to record a range of measurements (to include length/distance) ATb. use appropriate digital instruments (scaler and stopclock) ATk. use ICT such as computer modelling, or data logger with a variety of sensors to collect data, or use of software to process data ATI. use ionising radiation, including detectors				
Indicative apparatus	Gamma source (eg 5 μ Ci sealed cobalt 60), tongs to handle the sealed source, source holder, retort stand, boss and clamp, GM Tube suitable for gamma detection, scaler, stopclock, metre ruler.				
		Amount of choice			
		Increasing independence			
		Least choice	Some choice	Many choices	Full investigation
		Teacher gives students a full method with clear instructions as to how to set up the apparatus. All instruments and measurements are specified and students are instructed on the exact procedure and safety precautions.	Teacher allows students limited choice of distances to use. All procedural techniques, including requirement for a background count, are specified.	Teacher suggests outline investigation - by measuring intensity of gamma radiation at varying distances from the source. Student decides on most appropriate measuring instruments, counting times and range of distances from source. Student decides how to reduce uncertainty due to background radiation.	Teacher suggests general line of enquiry at the end of a piece of work where the student has had some experience in the use of ionising radiation and detectors. Student makes full decision about methodology, equipment and materials. All choices are fully justified with reference to experimental errors and safety.
Opportunities for observation and assessment of competencies					
Follow written procedures	✓✓✓ Students follow written method.	✓✓✓ Students follow written method.	✓✓✓ Students follow a method they have chosen.	✓✓✓ Students follow a method they have researched.	

Applies investigative approaches and methods when using instruments and equipment	✓ Students correctly use the equipment and materials with minimum assistance and prompting.	✓✓ Students correctly use the equipment, carry out procedures methodically and make adjustments when necessary.	✓✓✓ Students select and correctly use the equipment, carry out procedures methodically and identify and control quantitative variables.	✓✓✓ Student must choose an appropriate approach, equipment and techniques, identify variables for measurement and control.
Safely uses a range of practical equipment and materials	✓ Students must safely use the equipment following advice given, with particular reference to handling the gamma source.	✓✓ Students must safely use the equipment with minimal prompting, but following the specific advice given on handling the gamma source.	✓✓ Students minimise risks in all aspects of the investigation with no prompting, but following the advice given re: handling of the gamma source	✓✓✓ Students must carry out a full risk assessment and minimise risks. (Risk assessment details re: handling of the gamma source, to be approved in advance).
Makes and records observations	✓✓ Students record observations as specified in the method, and record in a methodical way using appropriate units and conventions.	✓✓✓ Students obtain accurate, precise and sufficient data and records this methodically using appropriate units and conventions.	✓✓✓ Students obtain accurate, precise and sufficient data and records this methodically using appropriate units and conventions.	✓✓✓ Students obtain accurate, precise and sufficient data and records this methodically using appropriate units and conventions.
Researches, references and reports	✓ Students process data in prescribed way and compare results with expected relationships.	✓✓ Students process data in prescribed way and compare results with expected relationships identifying potential discrepancies and errors, (and making appropriate correction for background radiation).	✓✓✓ Students identify appropriate methods/tools to process data and compare with expected relationships, identifying potential errors (eg due to background radiation and possible systematic errors in source-detector distance measurement).	✓✓✓ Students identify appropriate methods to process data, carry out research and report findings. Sources of information are cited together with supporting planning and conclusions.

✓✓✓: Very good opportunity ✓✓: Good opportunity ✓: Slight opportunity ✗: No opportunity

A-level Physics exemplar for required practical 12

Investigation of the inverse-square law for gamma radiation.

Teacher and technician sheet

This worksheet gives full details of the experiment, primarily for use by teachers and technicians who may be unfamiliar with the experiment. The worksheet would normally be adapted for student use to provide opportunity for students to make procedural decisions.

It is important that any 'student version' of this worksheet takes due account of any relevant safety issues. **It is the responsibility of the centre to ensure that the apparatus they provide is used safely.**

Materials and equipment

- gamma source (eg 185 kBq (5 μ Ci) Cobalt 60 'closed' source)
- source holder or retort stand, boss and clamp
- scaler with integral power supply for GM tube
- geiger muller tube suitable for gamma detection
- metre ruler
- stopclock.

Technical information

- **Teachers, technicians and students must be familiar with the regulations for the use and handling of radioactive materials.** "Managing Ionisation radiations and radioactive substances in schools and colleges" is publically available on the CLEAPSS website. (You do not have to be a member to download this document). This gives details of every aspect in the use of radioactive sources in schools, and we strongly recommend you refer to it for advice before doing this or other similar experiments.
- The most commonly used closed/sealed gamma source is Cobalt 60. This has a half-life of approximately 5 years. A (nominally) 185 Bq (5 μ Ci) source kept in school for 15 years would only have an activity of around 23 kBq (0.6 μ Ci), which may be too low to obtain satisfactory results.
- The scaler must be compatible with the GM tube used – ie it has the appropriate socket and voltage supply for the GM tube.
- When taking count readings the longer the count, the lower the uncertainty. It can be shown that the uncertainty in a total count of N is $\pm \sqrt{N}$. A total count of 400 will have an uncertainty of ± 20 or $\pm 5\%$.

Photographs of an exemplar set-up of this practical can be found in our set-up guide, which is available on our [A-level Practicals page](#).

Sample results

The table below shows sample readings for a Cobalt 60 source:

Background = 9	
Count	X / cm
291.00	5.00
187.00	10.00
94.00	15.00
59.00	20.00
29.00	30.00

Method

- Plug the GM tube into the scaler and set at the appropriate voltage (according to manufacturer's instructions). Start the scaler to check it is counting - there will be sufficient background radiation to register a count.
- **Before bringing the source into the laboratory**, a background count must be taken. Simultaneously start the scaler and stopclock. Stop the scaler after 20 minutes. Record the time, t , and the total count, N , on the scaler.
- Set up the arrangement as shown in the diagram.

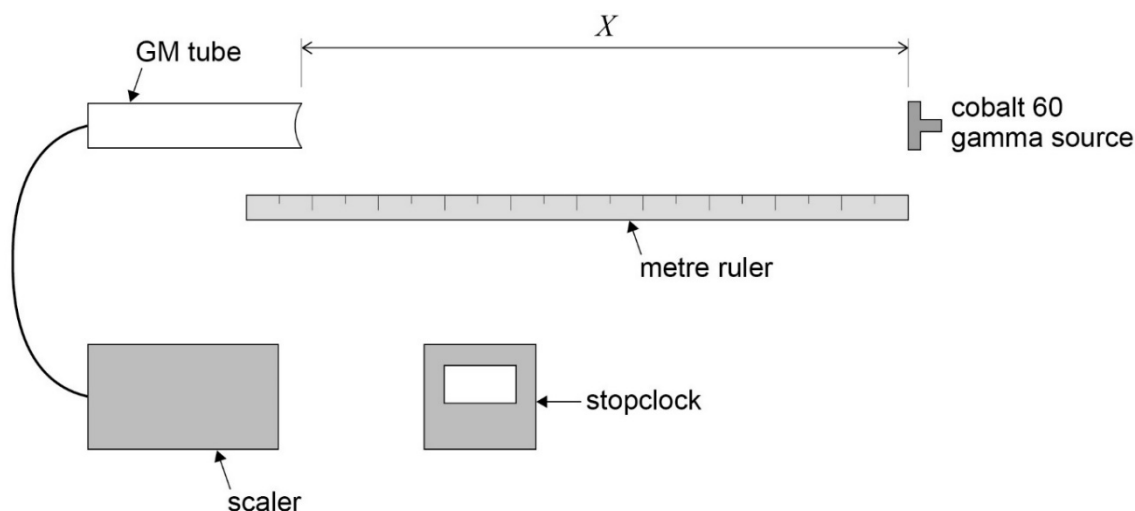

Clamps and source holder **not** shown. (Some stands with integral source hold, GM tube holder and mm scale are available.)

- Put the source in its holder (observing safety procedures).
- A few preliminary readings would be advantageous at this point, to establish the maximum distance at which a meaningful count can be taken – a count significantly above background is required to give useful data. Additionally, a count rate taken near to the source will enable counting times to be decided for smaller source-detector distances.
- Set the distance from the front of the source to the front of the GM tube window, X , to 600 mm. (Assuming this distance gives a satisfactory count rate.)
- Simultaneously start the timer and scaler, and take the count, N , after $t = 5$ minutes (or 10 minutes if the total count is below 400).
- Re-set the source position so that $X = 500$ mm from the GM tube and take the new total count after $t = 5$ minutes.
- Repeat for source - GM tube distances X of 400 mm, 300 mm, 200 mm, 100 mm. (As the source is placed closer to the detector, a shorter timed counts will be satisfactory).
- Record N , t , X in a suitable table, allowing columns for count rate $C = N/t$ and corrected count rate C' (obtained by subtracting background count rate from C) and a final column for $1/\sqrt{C'}$.
- Plot a graph with $1/\sqrt{C'}$ on the y -axis and X on the x -axis.

A straight line graph would verify the inverse square law relationship for gamma rays. The data is plotted this way around (rather than plotting C' against $1/x^2$), to eliminate the systematic error in distance measurement. The exact position of the gamma material inside the sealed source and the position inside the GM tube where ionisation takes place is not known. Actual distance between source and detector, d , is given by $d = x + e$, where e is the systematic error in the distance measurement. This distance e can be found from the intercept on the x -axis of the graph.

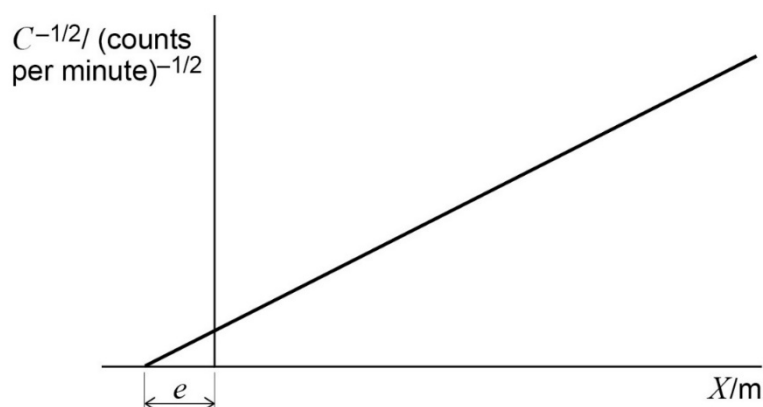

Appendix: questions from teachers

The following questions were received during our end-of-year webinar: [practical skills endorsement – best practice one year in – July 2016](#), after the first year of the practical endorsement. The answers were provided by Catherine Witter, our Lead Practical Adviser.

CPAC 1

Can you test a large group of students by getting them to do written answers to questions for CPAC 1? Some pupils are expressing concern quietly that they feel like they are being continuously assessed because of the directed questioning - do you have any advice as to how to get around this?

These two questions go together well. To pass CPAC 1, students need to follow the written instructions in the order written, be able to explain the reasons for doing each step and to collect a set of data that would be expected. If they complete some questions that secure independent access to the pass, that would be a good alternative to questioning them during the lesson.

Do you have to have an accompanying checklist for CPAC 1, or is it enough to record what a student did incorrectly?

When assessing students against CPAC 1, they need to be correctly carrying out the method steps in the right order. They also need to be able to explain why they are doing each step and to get a set of data that you would expect. Lots of teachers are choosing to keep a checklist to secure robust evidence against these assessment criteria but we will not ask to see it. Teachers can make records in whatever form they would like to, to allow them to make an accurate assessment.

Is it wrong to do a 'dry demo' of a titration and then next lesson students carry out the titration. You go round and ask question and award CPAC 1?

Teaching the general titration technique before expecting students to do it is good teaching, and this is the case before any assessment of CPAC is carried out. Dry demonstrating the practical method steps the lesson before they follow the written instructions is far less acceptable as the students need to independently show you that they can meet the pass standard in CPAC 1.

Circulating the laboratory and asking questions as they carry out the practical following written method steps provided will allow you to assess whether they can justify the reasons for carrying out each step. This is one of the assessment criteria for a pass in CPAC 1 and so would be good practice.

Do students have to complete all CPAC 1 for all 12 practicals?

To be endorsed for CPAC 1, your students will have to have consistently and routinely met the pass standard in CPAC 1. This may take three attempts; it may take all 12 attempts or more if you invite them to be assessed on your own level 3 challenge practical work. When you feel strongly, without question, that your students could follow a set of written instructions, justify the reasons for carrying out each step and collect a set of expected data totally independently of you – and when at university in their first year – then you are less likely to want to assess them on CPAC 1. They must be in this position at the end of the course and so only assessing CPAC 1 to this point in Year 12, for example, before stopping would not be recommended.

CPAC 2

You mentioned that writing a method showed mastery of CPAC 1. I thought writing up a method related to CPAC 2 not CPAC 1?

To demonstrate the pass standard for CPAC 2c, students must be able to write a method and determine which variables to change, control and measure.

To demonstrate the pass standard in CPAC 1, students must follow a written set of instructions provided, be able to explain why they are carrying out each step and collect expected data.

If students followed their own written method steps, providing that they have been carefully checked for both safety and to ensure they will generate expected data, that is a greater step towards total independence and hence a mastery of CPAC 1 is being developed.

Many teachers ask us “Is it okay if students plan a method but then I give them one to follow?”. Often the technician has not got the capacity (or sometimes the apparatus) to support several different methods being followed each time. Of course, we could support that and students would have access to the pass standard for CPAC 1 and 2c if given this task.

If a student is supposed to write their own method, why are they published by AQA in a handbook?

Writing a method is a skill that students need to develop. Our example practical work will give students access to the apparatus and techniques that they will be examined on. There are a multitude of practical experiments that you could ask your students to write a set of method steps for, to allow them to access this CPAC 2c strand.

Can we assess some CPAC areas for a plan of an investigation (not a required practical) even if the students don't carry out the practical itself?

Absolutely, yes. Aspects of CPAC 2 require students to be able to plan an investigation and if they do this successfully they would reach the pass standard in CPAC 2c. This can be set as a discrete task, you don't have to assess any other CPAC against the work they have done unless you choose to.

CPAC 3

For CPAC 3, if a student has broken glassware and not attempted to clean it up, does that mean they have failed for that time?

It is not as clear cut as that. For CPAC 3, students need to be able to identify major hazards, associated risks and control measures. During the practical lesson, they need to be observing the non-negotiable, practical specific safety measures.

Leaving broken glass on the desk or floor without dealing with it will certainly mean that the student has not reached pass standard on that occasion but will hopefully have partially met it. We would also like to think that teachers would report progress to students as them ‘not having shown evidence towards the pass on this occasion’ rather than the much stronger, negative word fail.

Is it physics' fault if students complete CPAC 3 on a simple and safe experiment - they can still carry out a full risk assessment sheet - it may just be limited?

Some practicals are much better vehicles to assess CPAC 3 as they present a greater challenge to students when identifying the major hazards, associated risks and control measures. There are practicals in physics that are more suitable. This includes required practicals 1, 2, 5 and 12 amongst others. All CPAC do not have to be assessed during every practical.

Is 3a about planning and identifying the hazards and risks, and 3b about the 'doing'?

Yes.

I showed my class a video for the required practical where they make cyclohexene as we do not have enough fume cupboards. I assessed them based on their risk assessment and planning, is this okay despite them not carrying it out themselves?

Assessing CPAC 3a in this way is absolutely fine for this practical although your students do need to complete a practical involving simple distillation. The cyclohexene preparation is a very routine example of how this technique can be used and refers to some important theory, which is why we have chosen it, but there are others. Please note that required practicals 5a or 5b can be used as alternatives as they both involve the use of simple distillation.

CPAC 4

When assessing CPAC 4, you've said 'full headings' are required - is it sufficient to write, for example, "T/s" in Physics as a heading for time period measured in seconds? This was always the preferred method for the old ISAs when standard symbols were used. Would abbreviations include 'V' in place of voltage etc?

There is a section in our practical handbooks to support teachers and their students to keep a record of data whilst carrying out practical work.

Does 'biological drawing' relate to CPAC 4?

Yes, this is a way of recording qualitative data. Please see one the 'Biological drawings guidance (CLEAPSS)' downloadable attachments on our [A-level practicals page](#) for support from CLEAPSS if that would be helpful in your own teaching.

We couldn't get good results for Physics practical 4 (Young modulus) despite ordering two new sets of apparatus. Is it okay for pupils to have poor results and assess that data and still get credit?

Some of the Biology practicals have not worked through no fault of the students. Can we still assess them on a practical that did not give the expected results?

To meet the pass standard for CPAC 4, students need to be able to design a suitable data table and record their data on collection. If the data was poor but is what you as their teacher would expect (as you also collected similar data) the students should not be penalised. If they then go on to process that data to formulate a conclusion, it would be a good exercise to then do some research and evaluate their data against a secondary source. This would open access to CPAC 5 in a very meaningful way.

Students had previously carried out individual test-tube reactions on individual chemicals and were asked to record observations on an unknown, but they could not record all observations and they could not identify the unknown. Can I award CPAC4?

From this information we would suggest they have not met the pass standard in CPAC 4. However, if they have carried out the chemical tests correctly after following a set of written instructions to get a set of data that you would expect, even if they could not independently record it, you may wish to give them credit for meeting the pass standard in CPAC 1 through this practical experience.

Is it still acceptable for students to record data in tables CPAC 4b to the same number of decimal places or do they have to record to same number of significant figures?

When recording data, students should record data to the correct resolution of the apparatus that they have used to collect that data. For example, a titration would be expected to be collected to two decimal places.

We were informed by AQA that practicals involving fume hoods could include demonstrations by the teacher (rather than having each pupil in a class taking a turn at a fume hood). If the pupils record observations, is this correct?

Could the pupils use their research to inform how the teacher should best carry out the demonstration etc? Would this pass the CPAC?

If you are only assessing CPAC 4 then this approach would be fine. If you had chosen to assess CPAC 1, demonstrations would clearly not be acceptable in the same lesson unless the student was struggling to meet the pass standard and you wanted to use demonstration at the time to improve their technique.

For the second part of your question I recommend using this research towards evidencing CPAC 3 and 5. Students could identify major hazards and associated risks to inform you how to carry out a safe demonstration. Their research could then be referenced fully.

Is it appropriate (due to lack of equipment) for individual or pairs of students to make one measurement (eg count rate at one distance) and then combine all results to get class set? (We only have one GM tube and gamma source).

If you can extend that to allow each individual to make a set of repeats of the same measurement, to allow them to independently collect and record a set of data, that would be more in keeping with the expected pass standard.

CPAC 5

In CPAC 5: "sources of information are cited demonstrating that research has taken place supporting planning and conclusions". This seemed to imply that it will inform the practical they are doing rather than "inform further practical work". Is it the latter?

The research element of CPAC 5 is to enable students to inform their past, current or future practical work. The potential for research use is large and spans: whether it is to support method planning, the apparatus to use, to compare the data collected to a secondary source or to support a conclusion or practical evaluation.

Students should be taught how to research most effectively and how to reference their sources to enable the source to be found again. Students should also have an understanding of the reliability of that resource of course as has been standard at GCSE level.

Do students need to use a system for referencing? Our school asks for Harvard system across the board. If pupils reference but not use Harvard what would I mark them as?

Our [CPAC student pen portraits](#) and [online practical endorsement training](#) show that the successful use of the Harvard system for example, would demonstrate mastery in this element of CPAC 5. If they did not do this but referenced the sources well to allow them to be found again, they would be meeting the pass standard.

If they research a method and it is not feasible to do (ie not the one they would use in class) would they still pass that CPAC?

Do they have to carry out their plan or can they be given a pre-prepared plan AFTER the research phase and still get a positive assessment?

Successful research to inform current or future practical work or to support evaluation of practical work has been done and, if referenced correctly, can be used for the assessment of CPAC 5. It is likely that teachers will give a written method of their own to follow for CPAC 1. This is absolutely fine as it is very likely that students will have chosen to use apparatus that may not be available in a routine school laboratory.

I marked a titration practical and gave feedback. Referencing was not as good as I wanted. They asked if they could redo the write-up after feedback. Can I still award CPAC 5 for the second draft or is it only the first draft that counts?

Students will have plenty of opportunity to access a pass on each of the CPAC areas as they go through the course. The first draft will count, the students concerned will have partially met CPAC 5, but they will have also understood what you require for referencing when they next meet some research work.

To meet the 'pass' standard, students must independently meet it consistently and routinely across all five competency areas by the end of the course. A second draft as described would mean that they hadn't independently achieved the CPAC 5b pass standard.

On CPAC 5 it says 'Uses appropriate software and/or tools to process data and report findings'. Must they use software to pass this, or would drawing graphs by hand, using calculators to perform calculations suffice?

A calculator is a tool and so, to gain evidence towards the pass for CPAC 5 this would suffice. However all the apparatus and techniques in the specification must be covered to ensure that your students have full access to the exam questions and so, if data can be collected and processed using dataloggers or Excel for example, that will be a good experience for your students to have.

For the award of CPAC 5, is it okay for students to write up instructions for testing for ions after having carried out the experiments?

If you are assessing CPAC 2, planning a method, then the way that you have described has not given them independent access to the task in hand as they have simply copied out the instructions given. They would not pass CPAC 5 on this occasion.

CPAC 5, Researches, references and reports involves data processing and referencing in addition to providing a structured report of what a student has done.

General queries

What level of detail is required in terms of marking the key practical assessments to show evidence that students have met the required competency standards?

Visiting advisers do not expect to see feedback given in any particular way. The majority of teachers are however using written feedback to communicate to their students how they might improve against the pass assessment criteria for any particular CPAC.

The adviser will be quality assuring teacher assessment of CPAC during their visit. If there is no feedback in student lab book records, it will be necessary for the adviser to question the subject teachers to ensure they can assess student work correctly.

Have schools used a standard proforma for marking and assessment of student practical work?

No. We will not be providing one as the [online practical endorsement training](#) clearly outlines what the pass standard looks like for all five CPAC areas. If you look on the website, you will find a teacher checklist that we have written, to crystallise the assessment criteria for pass. Teachers will then use those as guidance to think through in advance how the practical they are delivering will allow student access to those criteria.

We have provided an example set of 12 required practicals that together will ensure that students access all the apparatus and techniques they will need to be able to answer the practical questions in the written exams. Providing common proformas that all teachers mark to will, in effect, mean that we have gone backwards as teachers will then see them as 12 controlled assessments.

Teachers have the flexibility to assess CPAC as often as they want to, through any practical work of appropriate challenge they wish to. When teachers have fully grasped the key messages from the online training they will be in a position to assess CPAC accurately without the need for prescriptive mark schemes.

When two worksheets are given in the practical handbook for a required practical, for example 5a and 5b in Chemistry, do we need to do both, or is only one is enough? With my group, I only did 5b which required more skills compared to 5a.

In this case, 5a or 5b are optional, you were right to choose only one as they both gave the students the opportunity to experience simple distillation. You do need to ensure that you have covered the theory associated with both practical schedules.

However, required practicals 7 and 10 in Chemistry also each contain parts a and b. In the case of required practicals 7 and 10, these are not optional as they cover different apparatus and techniques and so students must complete practical work that covers those apparatus and techniques.

Will we have to send off the practical books to the EB?

Your monitoring visit is to quality assure teacher assessment of CPAC. Once we are confident that the assessment criteria can be applied accurately you can endorse your students at the end of Year 13 without providing further evidence.

What are the most common reasons why schools have not been endorsed?

Approximately 10% of schools and colleges who have already had their first monitoring visit require a second visit. Most commonly that is because subject teachers have not completed the necessary training to be able to apply the CPAC assessment criteria accurately. Tracking progress inaccurately is also a common reason.

Teachers are currently working very hard during the planning stage to enable students to access CPAC assessment regularly to enable students to eventually be able to 'consistently and routinely' meet the pass standard. Therefore if the planning documentation is not in place, more correspondence between the adviser and lead teacher will be required before the written report is finalised.

Do we notify AQA via e-AQA of the pass/not classified?

Yes. The final date for reporting this to AQA is 15 May each academic year.

Can students pass the A-level if they are 'not classified' in the practical skills endorsement?

Students will get a certificate in the A-level if they achieve a grade E or above overall. If they pass the practical skills endorsement and fail to achieve a grade, they will not receive a certificate. Students can therefore pass the A-level grades A*–E if they are given a non-classified report in their practical skills.

What is the consequence for getting a 'not classified'? What are the consequences of failing our AQA practical audit for pupils?

Higher education admissions tutors were a strong voice in A-level reform. Over time, AQA expects the practical endorsement reported to be a significant part of the student offer as universities get to grips with the changes to practical work.

We feel strongly that upwards of 95% of all students taking A-level sciences should be able to reach the pass standard and so pass the practical skills endorsement. Good science teachers will give their students many opportunities to hone their skills to ensure they can demonstrate them routinely and consistently.

Ofqual also plans to do some research. They will then be able to measure the impact of the changes to practical work assessment in the reformed specifications.

May the requirement of CPAC grades be classified in Distinction, Merit, Pass or Fail?

The only two ways of reporting the practical skills endorsement are 'pass' or 'non-classified'. Most teachers will encourage their students to demonstrate a mastery of the five CPAC however.

One of my students has missed their Biology TLC practical. We are also doing TLC in Chemistry - can they use evidence from the Chemistry practical for the Biology endorsement?

We agree that the TLC technique is the same regardless of subject. Please be aware that students often find applying their knowledge difficult, so it may be best to encourage a catch-up opportunity.

What is the best support we can give to our Chemistry technician who will have to do all practicals for A-levels and has no experience of A-level Biology or Physics?

We have recently surveyed a large number of science technicians who support teachers delivering A-level science. We suggest that you give them a copy of the practical handbook for each subject, where they will find technician notes. They may also [contact one of our technician advisers directly](#).

If they are not already a member of a technician forum, that might be something to consider. Many technicians tap into a support network every day to share best practice.

If we are only assessing 6–8 students in a lesson and only assessing one or two CPACs at a time and only tracking progress of the required practicals, there is a worry that we will not be able to get through all students and all CPACs isn't there?

Yes. For schools and colleges who plan only to deliver the minimum number of required practicals, detailed in our practical handbooks, this is a risk if the approach in the question is taken.

Assessment of CPAC needs to be robust however and manageable in the practical lesson time if teachers are assessing CPAC 1,2a, 2b, 2d, 3b and 4.

Teachers who adopt this approach are therefore utilising homework and testing well to enable CPAC assessment. Many teachers are recycling legacy ISA and EMPA questions that fit with CPAC assessment and using those.

I thought the *verbal feedback stamp* was out of date and frowned upon. Verbal feedback is usually always given. Surely a stamp does not confirm this? This seems to be here to tick certain boxes for school marking policy.

Feedback can be given to students in many ways and teachers will take the approach no doubt that is most beneficial to their own students and the progress they make against the CPAC.

Can students annotate their instruction sheets?

Often this is a good way of assessing CPAC 2b. When students are carrying out their written instructions, they may identify ways to adjust the method slightly to enable more accurate data to be collected. If CPAC 1 is the focus of assessment then students can only access the pass standard if they have followed the written instructions independently, and so annotation reflecting whole class support prior to the start of the practical would clearly not be conducive.

Can't we assess the 5 CPACs in each practical? Do you think an average student can meet all the CPAC standards in just the required practical work?

If teacher plans reflect a rigorous assessment of each CPAC area before the end of the course then we would support completion of the minimum 12 required practicals as enough to allow students to reach a pass in the endorsement.

All five CPAC can be assessed in a single practical experience yes, but it is unlikely that it would be possible in the practical lesson time alone, even for a handful of students. Using homework and test questions and time, maybe a lesson before and/or after the practical lesson itself, would allow teachers to plan specific activities through which all five competencies could be assessed.

When will the new tracker be available?

Our new trackers are [available on our website](#) now.

We have had an email saying an adviser is coming for our Biology A-level, but have not had communication regarding Chemistry. Will this be done on the same visit?

If we have already had a monitoring visit, would we get another one this year?

Small centres, where each subject has fewer than 140 entries, have one visit to one subject for each exam series.

If successful, all three subjects at the school or college can endorse their students by 15 May of the year of A-level entry.

How will you manage the monitoring visits to overseas schools such as ours?

All international schools and colleges who offer our qualifications worldwide will be contacted to arrange monitoring of their lesson, teacher records and student records.

Is a Physics example lab book on the AQA website? Is there anywhere centrally we can access each practical proforma already planned out like the one in worksheet 1 to save us all doing these?

This is not the type of resource we typically produce, but on the [practical website page](#) you will find the webinar recording, slides and a number of other useful resources.

The required practicals in our specifications are suggested practicals that incorporate the apparatus and techniques that students will be examined on. We aim to keep practical work at A-level very open and so will not be creating or sharing a set of materials bespoke to each of the 12 practicals.

Do you have additional support for teachers outside subject specialism? Do we have dates for the courses yet? Where can we find them?

We have run a number of very successful courses in Manchester and London. These courses are aimed at offering teachers the opportunity to carry out the 12 required practicals for themselves with guidance about how to integrate CPAC assessment.

You will find details in the science section of the [CPD area of our website](#).

Are you allowed to discuss which CPAC students need to work on more over the two-year course?

Many teachers are sharing the tracking documents with their students to inform which CPAC needs more work if they are to reach the pass standard and their practical skills be endorsed at the

end of year 13. We have seen many students tracking their own progress, interacting with teacher written feedback after practical work has taken place.

How do we carry out the distillation of ethanal practical given the recent safety concerns? We only have three fume cupboards.

Our required practicals are only suggestions. We have worked hard to incorporate the apparatus and techniques for teachers but recognise that teachers may wish to choose an alternative practical that incorporates simple distillation. Practical 5a or 5b are alternatives as they both include simple distillation, so only one needs to be completed. However, these are not the only options.

During the monitoring visit, do we have to show an endorsed practical?

During the visit, your adviser will need to see students doing some practical work. It can be any practical work of level 3 challenge; it does not need to be one of our 12 required practicals. The purpose of the visit is to quality assure teacher assessment and so it might be helpful to assess some of the CPAC criteria whilst teaching the lesson, although this is not compulsory.

Please could you advise how I can access the compulsory Lead Teacher online training? Do all teachers have to do the CPAC training and get their own certificate?

The [practical page of our website](#) signposts all the help that you will need to deliver the A-level practical work and endorsement of your students. Our Lead Teacher training is only compulsory for the Lead Teacher as indicated, but in our experience many teachers are completing the training. Many technicians are also completing it.

Do students need to complete a full write up for each practical?

That is entirely up to you and depends on what you require from the exercise. You may have assessed one of the competency areas and just need evidence for that, for example?

All the required practicals can be assessed through exams and so should be written up in a form that students can revise from.

If a student drops Physics, ie not studying in Year 13, do we need their documents for any reason?

The CPAC are generic across all three sciences and so if this applies we would recommend passing their work across to their other science teachers to provide extra evidence.

You will no longer need to keep your own records of the CPAC progress in Physics if they are not likely to take it any further or move to another establishment to study it.

Will the AQA examiner be looking at OCR courses at the centre? For example my Physics course is AQA, but Chemistry and Biology are OCR.

The AQA adviser, if allocated an AQA subject visit by JCQ, will only monitor the work done by teachers and students in that specific subject.

Do you have any tips to improve consistency of approach across the department?

There are many subject teams that have a large number of teachers and there are strategies they are using to secure strong quality assurance. We would advise discussing the practical work first as a team, deciding which CPAC might be more suitable to assess in each one, then collectively deciding on the assessment criteria you would be looking for uniformly.

Lots of teachers are using checklists to help them to do this but we would not be asking to see them during a monitoring visit.

CPAC5a and CPAC5b could be assessed in different experiments. How would that be recorded in the tracker?

Our [sample endorsement trackers](#) have a tab for each of the required practicals and there are also tabs to record teacher assessments after other practical work has been completed.

Holistically, as long as the 'pass' standard has been met in CPAC 5 consistently and routinely, the student can be endorsed in CPAC 5.

With Physics there are some practicals that require equipment we cannot afford to buy as class sets. How can we assess pupils for the CPACs for this?

We understand that equipment, particularly in Physics, can be costly. Students must be able to demonstrate the five competencies independently to be endorsed and many schools and colleges are using a carousel in practical Physics lessons for example to ensure this can happen with limited apparatus.

One of our students has transferred to us from another college which also used AQA. What are our responsibilities concerning CPACs?

As the second centre, you have full responsibility for the assessment of CPAC and the endorsement of this student's practical skills. They must be assessed at 'pass' standard consistently and routinely across all five CPAC areas and so in Year 13 it is important that he or she has many opportunities to demonstrate this to you.

I recognise that this is difficult and potentially very time consuming and so I recommend contacting the previous college and asking for any related documentation to be passed across to you. The student file with their AS work will also be a useful starting point for evidence of CPAC 4 and 5 for example.

You said many schools are doing more than 12 minimum practicals. I am struggling to fit in the 'official' practicals (recommended ones) but can I also include any other practicals?

Absolutely. The CPAC can be assessed through any level 3 challenge practical work as well as through the minimum 12 required practicals. Many schools and colleges are doing more to allow the teaching of practical technique or access to new apparatus (for example) before assessing students on the use of them.

It is also likely that some of your students will need a few more attempts at demonstrating a competency area before they are routinely and consistently reaching the expected pass standard.

For our visit next year, would you expect to see the work of students who are not continuing onto the full A-level?

The endorsement of practical skills happens at the end of Year 13 and so we would not need to see the work of any students who have chosen not to continue with the subject. During your visit a sample of work will be chosen from all students who are in Year 12 or 13. Your adviser will explain how we do this when they make contact with you.

We have class sizes of around 22. I would be interested in any approaches to carrying out necessary discussions with students during lesson time.

Perhaps consider only assessing one student in each pair, for example, during the lesson or if your lesson time is short, only a third of the class on any one occasion. This will depend on how many practicals you plan to do over the duration of the course.

Students need to be able to explain the reasons for carrying out each step as they do a practical if you are assessing CPAC 1. Using an associated homework or test question to allow them to do this may also be a valuable way of assessing numbers of students at any one time and we understand that this may be your preference.

If a student has achieved a CPAC during that particular practical, but not often enough for it to be 'consistently and routinely' - would this appear as green or amber on the endorsement tracker you've provided?

The trackers are optional resources, not required documentation. There is a practical tab for each of the required practicals and if you are using these over time, you might expect the student to meet the pass standard in each CPAC more regularly. In other words, moving through the tabs if the colour green is seen for CPAC 1 more often than not, the student is consistently and routinely meeting the pass standard.

If you are using just one sheet to record all progress made towards the pass standard in CPAC 1, you will be moving from red to amber through to green as you assess students are meeting the pass standard more and more over time. Through your records you make a note of how many times that you have given them access to each competency.

Can I tell students exactly what I will be looking for in order for them to pass a criterion before the practical?

This is common. It is perfectly acceptable to 'scaffold' a task to allow them to access the assessment criteria for 'pass'. Over time, the withdrawal of that scaffolding will allow students to become independent, which is indicative of a mastery of the competency area.

If a student doesn't meet the criteria for a particular part of a given CPAC, does this mean they fail their A-level? Also, if they do not meet the criteria for a given CPAC, are they allowed to repeat the practical?

Each student must meet the pass standard in all parts of all five CPAC, consistently and routinely, before the end of the course in order for you to endorse their practical skills.

Repeating a practical will not stretch or challenge a student but if students are struggling to meet the pass in CPAC 1 for example, access to another level 3 practical would allow them to demonstrate their ability to follow a set of written instructions. This would be the next step.

Will centres have the checklist that monitors have for their visit?

All the paperwork our advisers use to support their visit can be found on the [practicals page on our website](#). Most of this is also emailed out to the lead teacher when the adviser makes first contact.

I visited a school last week who said they had a record of the practicals and just ticks in the books. They were told more feedback was needed from the teachers. I'm feeling confused with the level of feedback you want us to give.

The adviser who carries out your visit will look at a sample of student lab book records and will be able to see if the pass standard has been reached across the CPAC areas. This is more difficult for the quality assurance of CPAC 1, 2a, 2b, 2d, 3b without teacher feedback as they are competencies that are assessed during a lesson as students manipulate apparatus, work safely etc.

Feedback can be given in many forms and is essentially for the student to make progress. If the adviser finds their quality assurance exercise difficult, with the absence of feedback to students, they will question teachers on assessment criteria. We will support you as much as you need to become fully fluent with all the CPAC assessment criteria both through our online training and other associated resources that you will find on our [practical](#) page of the website.

We were told that a hardback lab book was most appropriate during our monitoring visit. Can we continue to use exercise books or should we buy new ones?

Hard backed books are more resilient to everyday use and are most portable over time but are not the only way to correctly house practical work.

If a student completes a practical but does an incorrect calculation, can they still be awarded a CPAC? Also, if students are given an opportunity to correct the calculation is that work no longer acceptable for CPAC?

This depends on what you have chosen to assess as only CPAC 5 involves calculation work and data processing. CPAC 1, for example, assesses a student's ability to follow a set of written instructions and so, in this case your student could still access 'pass' if they collected an expected set of data.

If your students were given help after their first attempt at a calculation and you regard it as too much help for them to independently correct the calculation, then it may be a partial pass if most but not all of the calculation steps were carried out correctly.

For A-level Physics practical 12 (inverse square law for gamma radiation). Can I use UV Photo diode instead of gamma? A class set is cheaper to get than gamma. It works really well.

For a student to be awarded the practical endorsement, he or she must gain experience in all of the apparatus and techniques in the specification. This is a compulsory part of the full A-level course. AT I demands the use of ionising radiation, including detectors. It is therefore a requirement for the full A-level. Additionally, one of the required practicals is an investigation of the inverse-square law for gamma radiation, so we would expect students to be familiar with that particular experiment and its underlying principles.

Using a UV photodiode or an LDR would reinforce general skills in the inverse square law, but by itself, it is not a suitable replacement for AT 1 or Practical 12 as students are not gaining experience of using a source of ionising radiation.

It is clear that students must have, either individually or in a group, hands-on experience of the use of ionising radiation including the use of detectors. This can be achieved using simple domestic equipment that emits ionising radiation. Such equipment could consist of thorium-coated gas mantles or commercial smoke detectors of the type that include an alpha emitter.

In terms of a follow-up investigation, this could include a practical simulation involving radiation from the electromagnetic spectrum other than gamma radiation. It could also include spreadsheet analysis of raw data obtained from a gamma experiment, but which had not necessarily been obtained within the centre itself.

Get help and support

Visit our website for information, guidance, support and resources at aqa.org.uk/7408

You can talk directly to the Science subject team

E: science-gce@aqa.org.uk

T: 01483 477 756